

WAC[®]

LANDSCAPE LIGHTING



Table of Contents

12V LED LANDSCAPE LIGHTING

Accent	3 - 14	Cylinder Wall Mount	37 - 38
Wall Wash	15 - 20	Hardscape	39 - 42
3" In-Ground	21 - 22	Path & Area	43 - 59
Grand In-Ground	23 - 24	Bollard	60 - 74
Recessed Ingrounds + Indicator	25 - 30	Landscape Tape Lighting	75 - 84
Submersible	31 - 34	Deck & Patio	85 - 86
Tree Lights	35 - 36	Step Lights	87 - 94

120V EXTERIOR LED LIGHTING

Landscape	95 - 96
Endurance	97 - 108
Decorative	109 - 114

Transformers/Accessories	115 - 117
What's Unique and Patented to WAC	118
Photometrics	119 - 130
Index	131

Cover Photo Credit: Vincent Landscapes, Inc.

ABOUT WAC LANDSCAPE® LIGHTING

Your Vision. WAC Delivers

WAC Lighting is a second generation family-owned and operated lighting company with a reputation for quality spanning 40 years. We have a history of inventing and making innovation widely available to the market through competitive pricing and reputable distribution partnerships.

Our choice has consistently been to operate at a higher level of responsibility, giving our customers the true benefits of a world class factory-owned relationship.

Headquartered in New York, we have facilities in New York, California, Georgia, and Texas, and use dedicated factories in Asia to support comprehensive research, design, engineering, electronics, fabrication, manufacturing, and testing operations worldwide.

WAC Landscape Lighting is an expansion of our lighting technology brand to offer ground-breaking patented solutions to the irrigation and green industry that address problems currently not addressed by other landscape lighting companies.





ACCENT

Our fully adjustable, integrated landscape Accent Lights feature multiple, lockable beam angles, and wattage controlled directly onboard to direct light as desired on shrubbery, hedgerows, arbors, and other outdoor spaces.

GRAND ACCENT LANDSCAPE

PATENTED



IP66



1838 listed
1598 listed

- New 4000K color temperature option resembles moonlight
- Adjustable beam 15° to 60°
- Continuously adjustable lumen output 740–2000 lm
- Integral brightness control
- One fixture replaces various higher wattage halogen accent lights



Ordering Chart

12V	120V	Fixture Finish Options:	
5211-27 5211-30 5211-40	5212-30 5212-40	BK	Black on Aluminum
		BZ	Bronze on Aluminum
		BBR	Bronze on Brass

Example: **5211-30BK**

	Input	Power	Brightness	Beam Angle	Color Temp	CRI	Rated Life
12V	9 - 15VAC	15W - 33W 21VA - 44VA	740lm - 2000lm	15° - 60°	2700K, 3000K, 4000K	85	45,000 hours
					Transformer Required (order separately)		
120V	120VAC	13W - 31W 23VA - 48VA	780lm - 2050lm	15° - 60°	3000K, 4000K	85	45,000 hours

See photometric data on page 119 / 120

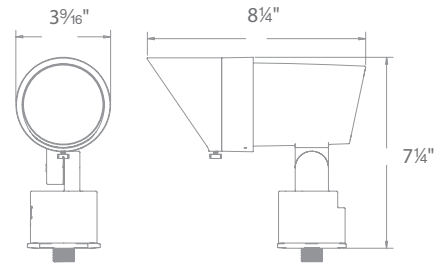

Accessories

5" Long Shroud	Grand Accent Snoot	Mounting Stake	Power Stake	Surface Mount Flange/Stake	Guardian Mount	Gutter Mount Bracket	Tree Mount Junction Box
5211-LSHR-BK	5211-SNOOT-BK	9000-ST9-BZ	M6000-STAKE	5000-SCP-BK	9000-SP9-BZ	5000-GM-BK	5000-TCP-BK
5211-LSHR-BZ	5211-SNOOT-BZ	9000-ST14-BZ		5000-SCP-BZ		5000-GM-BZ	5000-TCP-BZ
5211-LSHR-BBR	5211-SNOOT-BBR			5000-SCP-BBR		5000-GM-WT	5000-TCL-BK
							5000-TCL-BZ

9" Mounting stake (12V), detachable shroud, 6' lead wire and direct burial gel filled wire nuts (12V) included
See Accessories page for more detail

Large Tree Mount Canopy Strap	Extension Rods	Optics
5000-TST-BK	5000-X04-BZ,BK,BBR	LENS-25-AMB
5000-STB-BK	5000-X08-BZ,BK,BBR	LENS-25-GRN
	5000-X12-BZ,BK,BBR	LENS-25-RED
	5000-X18-BZ,BK,BBR	LENS-25-BLU
	5000-X24-BZ,BK,BBR	LENS-25-FR
		LENS-25-SPR
		LENS-25-BEL
		5211-HCL

MOONLIGHTING EFFECT

Introducing the first landscape accent lights to deliver up to 2000 lumens of light output. When mounted high in trees and pointing downward, Grand Accent creates a beautiful moonlighting effect with a cool white light and superior lumen output.

GRAND ACCENT
LANDSCAPE

	Input	Power	Brightness	Beam Angle	Color Temp	CRI	Rated Life
12V	9 - 15VAC	1W - 18W 2VA - 23VA	50lm - 1160lm	10° - 60°	2700K, 3000K, 4000K	85	70,000 hours
Transformer Required (order separately)							
120V	110V - 120VAC	3.5W - 14.5W	100lm - 900lm	15° - 60°	3000K	85	45,000 hours

See photometric data on page 121 / 122

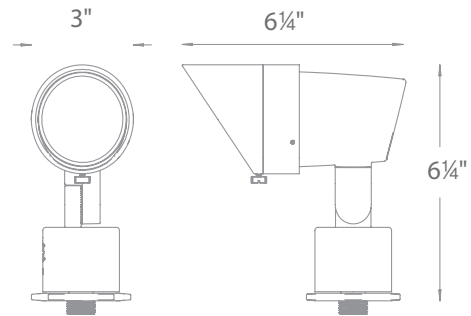

- Continuously Adjustable Beam Angles Indexed at 10°, 25°, 40°, 60°



- Continuously Adjustable Brightness Control Indexed at 1W, 2W, 8W, 15W, 18W

ACCENT
LANDSCAPE



1838 listed
1598 listed



PATENTED

ACCENT LANDSCAPE



12V

- Both fixture level dimming and circuit level dimming
- Dim each circuit from either the 12V or 120V side
- Adjustable beam angle 10° to 60°

120V

- Adjustable beam angle 15° to 60°
- Simple to retrofit existing line voltage systems or coordinate well with a new commercial landscape job

Ordering Chart

12V	120V	Fixture Finish Options:	
5011-27 5011-30 5011-40	5012-30	BK BZ BBR	Black on Aluminum Bronze on Aluminum Bronze on Brass

Example: **5011-30BK**

Accessories

6" Long Shroud	Accent Snoot	Mounting Stake	Power Stake	Surface Mount Flange/Stake	Guardian Mount	Gutter Mount Bracket	Tree Mount Junction Box
5010-LSHR-BK 5010-LSHR-BZ 5010-LSHR-BBR	5010-SNOOT-BK 5010-SNOOT-BZ 5010-SNOOT-BBR	9000-ST9-BZ 9000-ST14-BZ	M6000-STAKE	5000-SCP-BK 5000-SCP-BZ 5000-SCP-BBR	9000-SP9-BZ	5000-GM-BK 5000-GM-BZ 5000-GM-WT	5000-TCP-BK 5000-TCP-BZ 5000-TCL-BK 5000-TCL-BZ

9" Mounting stake (12V), detachable shroud, 6' lead wire and direct burial gel filled wire nuts (12V) included

Transformer Required (order separately)
See Accessories page for more detail

Large Tree Mount Canopy Strap

5000-TST-BK
5000-STB-BK

Extension Rods

5000-X04-BZ,BK,BBR
5000-X08-BZ,BK,BBR
5000-X12-BZ,BK,BBR
5000-X18-BZ,BK,BBR
5000-X24-BZ,BK,BBR

Optics

LENS-20-AMB
LENS-20-GRN
LENS-20-RED
LENS-20-BLU
LENS-20-FR
LENS-20-SPR
LENS-20-BEL
5011-HCL

MINI ACCENT LANDSCAPE

PATENTED



1838 listed

- Integral brightness control
- Adjustable beam angle 10° to 50°
- One fixture replaces various halogen accent lights.



Ordering Chart

12V	Fixture Finish Options:
5111-27	BK Black on Aluminum
5111-30	BZ Bronze on Aluminum
	BBR Bronze on Brass
	WT White on Aluminum

Example: **5111-30BK**

Input	Power	Brightness	Beam Angle	Color Temp	CRI	Rated Life
9 - 15VAC	1W - 7W 2VA - 7.6VA	45lm - 365lm	10° - 50°	2700K, 3000K	85	70,000 hours

9" Mounting stake (12V), detachable shroud, 6' lead wire and direct burial gel filled wire nuts (12V) included
Transformer Required (order separately)
See photometric data on page 124

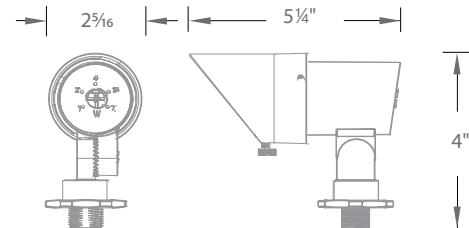

Accessories

5" Long Shroud	Mini Accent Snoot	Mounting Stake	Power Stake	Surface Mount Flange/Stake	Guardian Mount	Gutter Mount Bracket	Tree Mount Junction Box
5111-LSHR-BK	5111-SNOOT-BK	9000-ST9-BZ	M6000-STAKE	5000-SCP-BK	9000-SP9-BZ	5000-GM-BK	5000-TCP-BK
5111-LSHR-BZ	5111-SNOOT-BZ	9000-ST14-BZ		5000-SCP-BZ		5000-GM-BZ	5000-TCP-BZ
5111-LSHR-BBR	5111-SNOOT-BBR			5000-SCP-BBR		5000-GM-WT	5000-TCL-BK 5000-TCL-BZ

See Accessories page for more detail

Large Tree Mount Canopy Strap	Extension Rods	Optics
5000-TST-BK	5000-X04-BZ,BK,BBR	LENS-16-AMB
5000-STB-BK	5000-X08-BZ,BK,BBR	LENS-16-GRN
	5000-X12-BZ,BK,BBR	LENS-16-RED
	5000-X18-BZ,BK,BBR	LENS-16-BLU
	5000-X24-BZ,BK,BBR	LENS-16-FR
		LENS-16-SPR
		LENS-16-BEL
		5111-HCL



Shown with gutter mount bracket accessory



Continuously adjustable brightness control



Single and Double stem mount available. See next page



PATENTED

MINI ACCENT PATH

6111

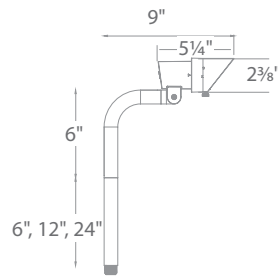

6211

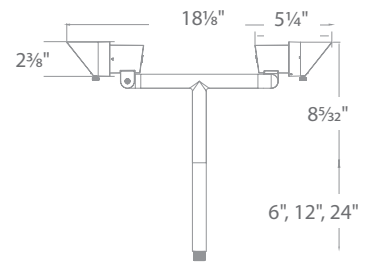
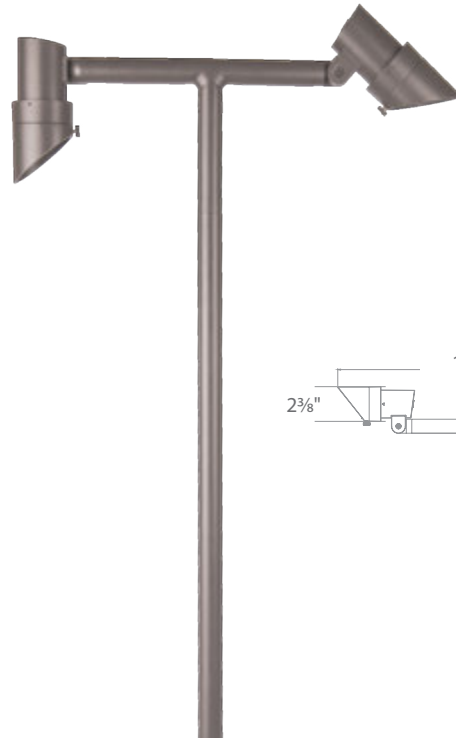

- Includes 6", 12" and 24" extensions
- 10°-50° beam adjustability
- Continuously adjustable beam angles and brightness control
- Detachable shroud
- Constant output for 9V-15V input

Input	Power	Brightness	Color Temp	CRI	Rated Life
9 - 15VAC	1W - 7W 2VA - 7.6VA	45lm - 365lm	2700K, 3000K	85	70,000 hours
9 - 15VAC	1W - 7W x2 2VA - 7.6VA x2	45lm - 365lm x2	2700K, 3000K	85	70,000 hours

See photometric data on page 124

Ordering Chart

Single	Double
6111-27	6211-27
6111-30	6211-30

Fixture Finish Options:	
BZ	Bronze on Aluminum
BBR	Bronze on Brass

Example: **6111-30BBR**

Accessories

5" Long Shroud	14" Mounting Stake	Surface Mount Flange/Stake	Guardian Mount
5111-LSHR-BZ 5111-LSHR-BBR	9000-ST14-BZ	5000-SCP-BK 5000-SCP-BZ 5000-SCP-BBR	9000-SP9-BZ

Transformer Required (order separately)

See Accessories page for more detail

- MLV Dimmable (remote MLV dimmer)
- Adjustable beam angle 20° to 60°
- One adjustable light replaces multiple lights with different optics, sizes and styles.



Ordering Chart

12V

Fixture Finish Options:

5311-27 **5411-27**
5311-30 **5411-30**

BK *Black on Aluminum*
BZ *Bronze on Aluminum*

Example: **5311-30BK**

Accessories

5" Long Shroud	Mini Accent Snoot	Mounting Stake	Power Stake	Surface Mount Flange/Stake	Guardian Mount	Gutter Mount Bracket	Tree Mount Junction Box
5111-LSHR-BK	5111-SNOOT-BK	9000-ST9-BZ	M6000-STAKE	5000-SCP-BK	9000-SP9-BZ	5000-GM-BK	5000-TCP-BK
5111-LSHR-BZ	5111-SNOOT-BZ	9000-ST14-BZ		5000-SCP-BZ		5000-GM-BZ	5000-TCP-BZ
5111-LSHR-BBR	5111-SNOOT-BBR			5000-SCP-BBR		5000-GM-WT	5000-TCL-BK 5000-TCL-BZ

9" Mounting stake (12V), detachable shroud, 6' lead wire and direct burial gel filled wire nuts (12V) included
Transformer Required (order separately)
See Accessories page for more detail

Large Tree Mount Canopy Strap	Extension Rods	Optics
5000-TST-BK	5000-X04-BZ,BK,BBR	LENS-16-AMB
5000-STB-BK	5000-X08-BZ,BK,BBR	LENS-16-GRN
	5000-X12-BZ,BK,BBR	LENS-16-RED
	5000-X18-BZ,BK,BBR	LENS-16-BLU
	5000-X24-BZ,BK,BBR	LENS-16-FR
		LENS-16-SPR
		LENS-16-BEL
		5111-HCL

Model	Input	Power	Brightness	Beam Angle	Color Temp	CRI	Rated Life
5311	9 - 15VAC	6W / 7.7VA	475lm	20° - 60°	2700K, 3000K	85	70,000 hours
5411	9 - 15VAC	3W / 5.5VA	245lm	20° - 60°	2700K, 3000K	85	70,000 hours

See photometric data on page 123

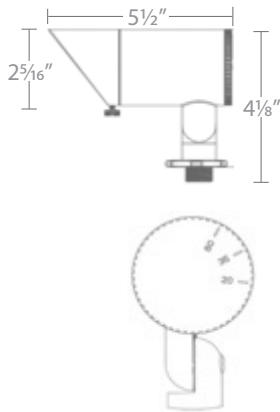

INTERBEAM
LANDSCAPE

- Die-cast brass construction
- Adjustable beam 20° to 70°



Ordering Chart

12V

5611-27
5611-30

Fixture Finish Options:

BBR Bronze on Brass

Example: **5611-30BBR**

Input	Power	Brightness	Beam Angle	Color Temp	CRI	Rated Life
9 - 15VAC	10.5W / 16VA	820lm	20° - 70°	2700K, 3000K	85	45,000 hours

See photometric data on page 123
Transformer Required (order separately)

Accessories

9" Mounting Stake	Surface Mount Flange/Stake	Gutter Mount Bracket	Tree Mount Junction Box	Large Tree Mount Canopy Strap
9000-ST9-BZ	5000-SCP-BK 5000-SCP-BZ 5000-SCP-BBR	5000-GM-BK 5000-GM-BZ 5000-GM-WT	5000-TCP-BK 5000-TCP-BZ 5000-TCL-BK 5000-TCL-BZ	5000-TST-BK 5000-STB-BK

9" Mounting stake included
12' lead wire and direct burial gel filled wire nuts included
See Accessories page for more detail

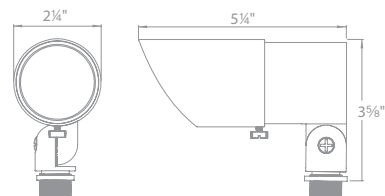



HORNET
LANDSCAPE





WALL WASH

Our problem-solving Wall Wash fixtures are easy to specify and install with flawless results. Deliver broad, even illumination to beautifully illuminate facades, shrubbery, trees, and other landscape elements.

ADJUSTABLE BEAM WALL WASH

LANDSCAPE | WITH BEAM AND INTEGRAL BRIGHTNESS CONTROL

PATENTED



1838 listed
1598 listed

- Continuously adjustable NEMA beam distribution 3x4 (35°x60°), 4x5 (60°x90°), 5x6 (90°x120°)
- Integral brightness control
- Rotatable fixture head for vertical distribution
- Solid die-cast brass or corrosion resistant aluminum alloy
- Simple to retrofit existing line voltage systems or coordinate well with a new commercial landscape job



Ordering Chart

12V	120V	Fixture Finish Options:	
5221-27 5221-30	5222-27 5222-30	BK BZ BBR	Black on Aluminum Bronze on Aluminum Bronze on Brass

Example: **5221-30BK**

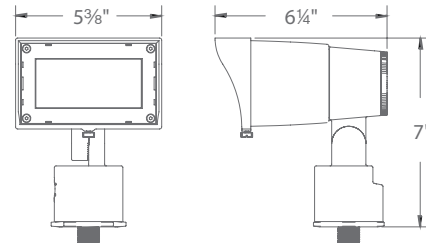

	Input	Power	Brightness	Beam Angle	Color Temp	CRI	Rated Life
12V	9 - 15VAC	3W - 25W 4.4VA - 27.8VA	200lm - 1500lm	Assorted NEMA distributions	2700K, 3000K	85	70,000 hours
					Transformer Required (order separately)		
120V	110V - 120VAC	3W - 25W	200lm - 1550lm	Assorted NEMA distributions	2700K, 3000K	85	45,000 hours

See photometric data on page 130

Accessories

Mounting Stake	Surface Mount Flange/Stake	Guardian Mount	Gutter Mount Bracket	Tree Mount Junction Box	Large Tree Mount Canopy Strap	Optics
9000-ST14-BZ	5000-SCP-BK 5000-SCP-BZ 5000-SCP-BBR	9000-SP9-BZ	5000-GM-BK 5000-GM-BZ 5000-GM-WT	5000-TCP-BK 5000-TCP-BZ 5000-TCL-BK 5000-TCL-BZ	5000-TST-BK 5000-STB-BK	LENS-3X5-AMB LENS-3X5-GRN LENS-3X5-RED LENS-3X5-BLU LENS-3X5-FR LENS-3X5-SPR LENS-3X5-BEL 5221-HCL

14" Mounting stake (12V), detachable shroud, 6' lead wire and direct burial gel filled wire nuts (12V) included

See Accessories page for more detail



ADJUSTABLE BEAM
WALL WASH
LANDSCAPE

Architectural beam distributions from 3x4 to 5x6 proportions and everything in between.
Always a uniform wide beam wash of light.



NEMA 5x4

NEMA 4x5

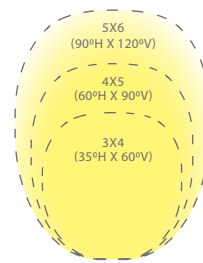
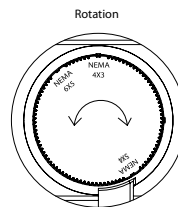
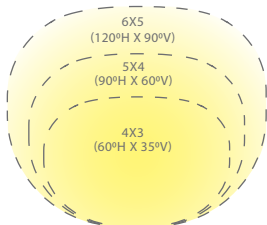
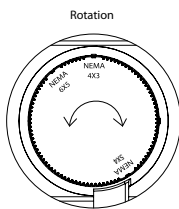

WALL WASH LANDSCAPE

PATENTED



1838 listed
1598 listed



- A uniform wide distribution wall wash from a small form factor
- Solid die-cast brass or corrosion resistant aluminum alloy
- Factory sealed watertight fixtures
- Constant output for 9V-15V, 110V - 120V inputs
- Even Coverage at 15° Upwards, 50° x 80°
- Continuously Adjustable Brightness Control indexed at 1W, 4W, 8W, 13W, 18W

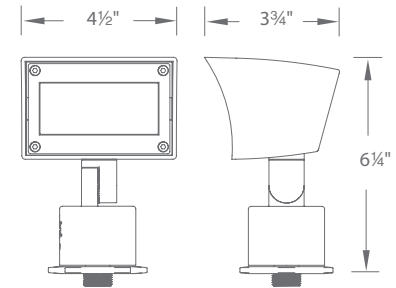

Ordering Chart

12V	120V	Fixture Finish Options:	
5021-27 5021-30	5022-30	BK BZ BBR	Black on Aluminum Bronze on Aluminum Bronze on Brass

Example: **5021-30BK**

	Input	Power	Brightness	Beam Angle	Color Temp	CRI	Rated Life
12V	9 - 15VAC	1W - 18W 2VA - 23VA	190lm - 980lm	15° upward (50° by 80°)	2700K, 3000K	85	70,000 hours Transformer Required (order separately)
120V	110V - 120VAC	3.5W - 14.5W	95lm - 855lm	15° upward (50° by 80°)	3000K	85	45,000 hours

See photometric data on page 129

Accessories

Mounting Stake	Power Stake	Surface Mount Flange/Stake	Guardian Mount	Gutter Mount Bracket	Tree Mount Junction Box	Large Tree Mount Canopy Strap
9000-ST9-BZ 9000-ST14-BZ	M6000-STAKE	5000-SCP-BK 5000-SCP-BZ 5000-SCP-BBR	9000-SP9-BZ	5000-GM-BK 5000-GM-BZ 5000-GM-WT	5000-TCP-BK 5000-TCP-BZ 5000-TCL-BK 5000-TCL-BZ	5000-TST-BK 5000-STB-BK

9" Mounting stake (12V), detachable shroud, 6' lead wire and direct burial gel filled wire nuts (12V) included
See Accessories page for more detail

Extension Rods	Rod L -Coupler	Optics
5000-X04-BZ,BK,BBR 5000-X08-BZ,BK,BBR 5000-X12-BZ,BK,BBR 5000-X18-BZ,BK,BBR 5000-X24-BZ,BK,BBR	5000-LCO-BK 5000-LCO-BZ	LENS-2X4-AMB LENS-2X4-GRN LENS-2X4-RED LENS-2X4-BLU LENS-2X4-FR LENS-2X4-SPR 5021-HCL



PATENTED

MINI WALL WASH

LANDSCAPE | WITH DUAL CCT AND INTEGRAL BRIGHTNESS CONTROL

- Integral brightness control. Select color temperature option
- Mounting stake and direct burial gel filled wire nuts all included
- A uniform wide distribution wall wash from a small form factor



Ordering Chart

12V	Fixture Finish Options:
5121-27/30	BK Black on Aluminum BZ Bronze on Aluminum BBR Bronze on Brass WT White on Aluminum
Example: 5121-27/30BZ	

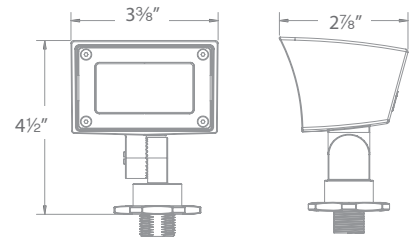

Input	Power	Brightness	Beam Angle	CCT	CRI	Rated Life
9 - 15VAC	1W - 8W 2VA - 12VA	80lm - 420lm	Symmetrical (70° by 90°)	2700K, 3000K	85	70,000 hours

See photometric data on page 129

Accessories

Mounting Stake	Surface Mount Flange/Stake	Guardian Mount	Gutter Mount Bracket	Tree Mount Junction Box	Large Tree Mount Canopy Strap	Extension Rods	Optics
9000-ST9-BZ	5000-SCP-BK	9000-SP9-BZ	5000-GM-BK	5000-TCP-BK	5000-TST-BK	5000-X04-BZ,BK,BBR	LENS-2X3-AMB
9000-ST14-BZ	5000-SCP-BZ		5000-GM-BZ	5000-TCP-BZ	5000-STB-BK	5000-X08-BZ,BK,BBR	LENS-2X3-GRN
	5000-SCP-BBR		5000-GM-WT	5000-TCL-BK		5000-X12-BZ,BK,BBR	LENS-2X3-RED
				5000-TCL-BZ		5000-X18-BZ,BK,BBR	LENS-2X3-BLU
						5000-X24-BZ,BK,BBR	LENS-2X3-FR
							LENS-2X3-SPR
							LENS-2X3-BEL
							5121-HCL

9" Mounting stake (12V), detachable shroud, 6' lead wire and direct burial gel filled wire nuts (12V) included
 Transformer Required (order separately)
 See Accessories page for more detail

3" Inground Features

Adjust Beam Angles
Presets at 15°, 30°, 45°, 60°



Tilt and Aim
Up to 40° of adjustability preset at -20°, -10°, 0°, 10°, 20°



Control Brightness
Adjustable from 70 lm to 505 lm
Presets Comparable to 10W, 25W, 35W, 50W, 75W
Halogen source



**3" INGROUND
LANDSCAPE**



1838 listed
1598 listed



IP67

PATENTED

3" INGROUND LANDSCAPE

- Integral brightness control
- Adjustable beam angle
- Directional aim with +/- 20° Tilt (12V ONLY)



Ordering Chart

12V	120V	Fixture Finish Options:	
5031-27 5031-30	5032-30	BZ BBR	Bronze on Aluminum Bronze on Brass

Example: **5031-30BZ**

	Input	Power	Brightness	Beam Angle	Color Temp	CRI	Rated Life
12V	9 - 15VAC	2W - 12W 2VA - 17VA	70lm - 505lm	15° to 60°	2700K, 3000K	85	55,000 hours
120V	110V - 120VAC	3W - 11.5W	65lm - 515lm	15° to 60°	3000K	85	45,000 hours

Transformer Required (order separately)

See photometric data on page 125 / 126

Accessories

Non-Slip Lens	Rock Guard	Optics	Concrete Pour Kit
5030-NSLEN-CL	5030-GRD-BZ 5030-GRD-BBR	LENS-25-AMB LENS-25-GRN LENS-25-RED LENS-25-BLU LENS-25-FR LENS-25-HCL	5030-PIP-PVC

6' lead wire and direct burial gel filled wire nuts (12V) or standard wire nuts (120V) included

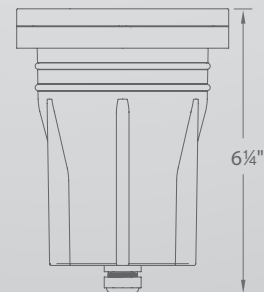
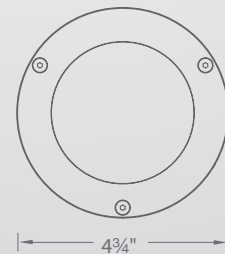



- Integral brightness control
- Adjustable beam 20° to 60°
- Directional aim with +/- 20° Tilt

Ordering Chart

12V

Fixture Finish Options:

5033-27
5033-30

BZ Bronze on Aluminum
BBR Bronze on Brass

Example: **5033-30BZ**

Input	Power	Brightness	Beam Angle	Color Temp	CRI	Rated Life
12V 9 - 15VAC	2W - 25W	105lm - 2000lm	20° to 60°	2700K, 3000K	85	55,000 hours

Transformer Required (order separately)
See photometric data on page 127

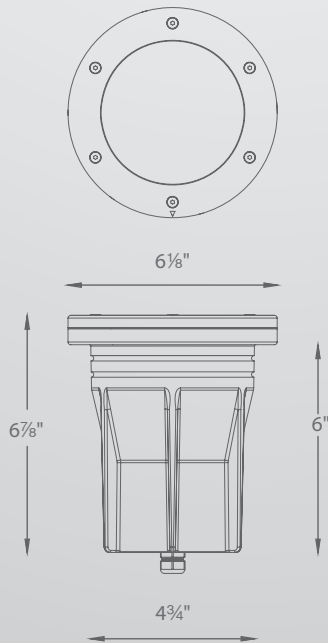

Accessories

Rock Guard

Concrete Pour Kit

5830-GRD-BZ
5830-GRD-BBR

5830-PIP-PVC

6' lead wire and direct burial gel filled wire nuts (12V)

Grand Inground Features



GRAND INGROUND
LANDSCAPE





INGROUND + INDICATOR

Indicator Lights provide soft, diffused lighting and are factory-sealed to prevent any degradation or water intrusion. Each Indicator fixture is constructed of solid stainless steel construction for durability and resistance against the elements.

SURFACE MOUNT INDICATOR LED LIGHT



2" APERTURE



2541-27	BS
2541-30	SS

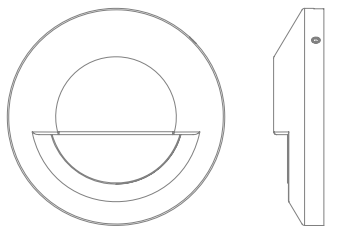

2 7/8" | 1 1/16"



2511-27	BS
2511-30	SS

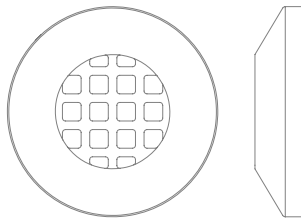

2 7/8" | 1 1/16"

Fixture Finish Options:

BS	Bronze Stainless Steel
SS	Stainless Steel

Example: **2541-27SS**

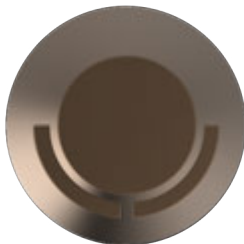

2591-27	BS
2591-30	SS

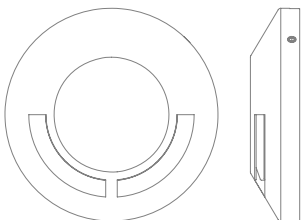

2 7/8" | 1 1/16"

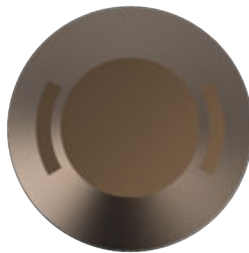

2571-27	BS
2571-30	SS

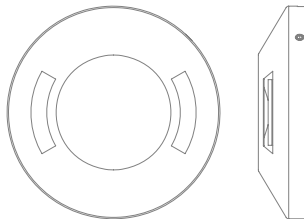

2 7/8" | 1 1/16"

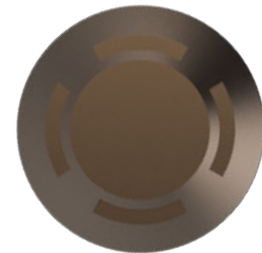

2501-27	BS
2501-30	SS

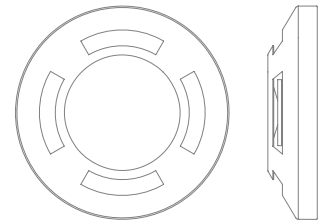

2 7/8" | 1 1/16"

Input	Power	Brightness	Color Temp	CRI	Rated Life
9-15VAC	2.8W - 3VA	3.5lm - 60lm	2700K, 3000K	90	60,000 hours

Transformer Required (order separately)
10' Lead Wire Included



SURFACE MOUNT INDICATOR
LED LIGHT

1" RECESSED INGROUND + INDICATOR LANDSCAPE



1" APERTURE

- Factory sealed watertight fixtures
- Solid stainless steel construction
- Options for use in outdoor downlight applications
- Constant output for 9V-15V input
- 100%-10% dimming - see specification sheet for list of tested dimmers
- Transformer Required (order separately)

Fixture Finish Options:

- BS** Bronze Stainless Steel
- SS** Stainless Steel

Example: **1011-30SS**



1" Slim Round

1011-27
1011-30 | **SS**

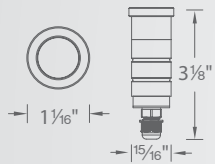

1" Round

1021-27
1021-30 | **SS**

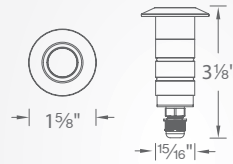

1" Square

1051-27
1051-30 | **SS**

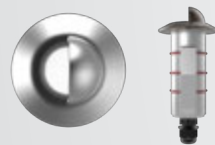
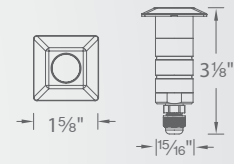

1" Scoop

1061-27
1061-30 | **BS**
SS

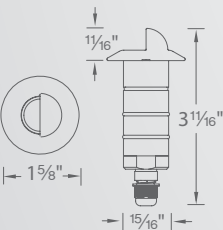

1" Shroud

1031-27
1031-30 | **BS**
SS

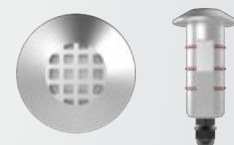
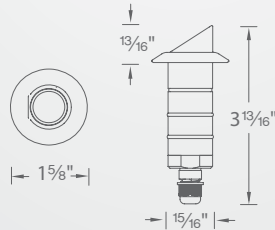

1" Louver

1041-27
1041-30 | **BS**
SS

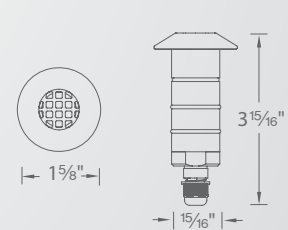

6' Lead Wire included

Optional spring clip accessory included

Optional spring clip accessory included

Input	Power	Brightness	Beam Angle	Color Temp	CRI	Rated Life	Accessories
9-15VAC	1.9W / 3VA	Up to 80 lm	50° (When an open top is used)	2700K, 3000K	85	70,000 hours	1" Concrete Pour Kit 1000-CON-PVC

Transformer Required (order separately)
See Accessories page for more detail



2" RECESSED INGROUND + INDICATOR LANDSCAPE

2" APERTURE

- Factory sealed watertight fixtures
- Solid stainless steel construction
- Constant output for 9V-15V input
- 100%-10% dimming - see specification sheet for list of tested dimmers
- Available concrete pour kit with 18" PVC pipe which can be field shortened
- Optional spring clip accessory included



2" Ground Hood
Beam Angle:
Asymmetrical

2081-27	BS
2081-30	SS

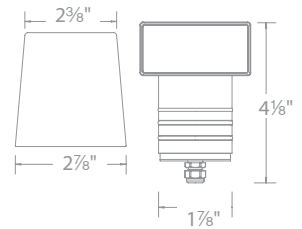

2" Slim Round

2" Slim Round with
Honeycomb Louver

2011-27	BS
2011-30	SS

2012-27	BS
2012-30	SS



2" Round

2" Round with
Honeycomb Louver

2021-27	BS
2021-30	SS

2022-27	BS
2022-30	SS



2" Square

2" Square with
Honeycomb Louver

2051-27	BS
2051-30	SS

2052-27	BS
2052-30	SS



2" Shroud

2111-27	BS
2111-30	SS

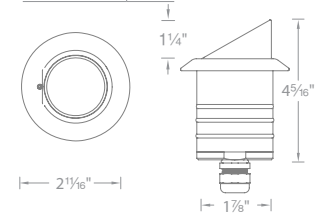
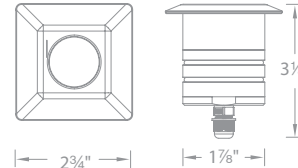
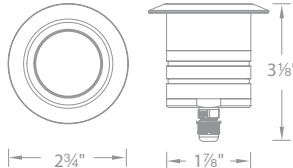
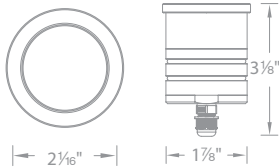

2" Quad Directional

2101-27	BS
2101-30	SS

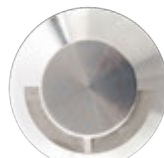

2" Single Direction

2091-27	BS
2091-30	SS

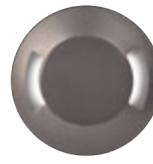

2" Bi-Directional

2071-27	BS
2071-30	SS



2" Scoop

2131-27	BS
2131-30	SS

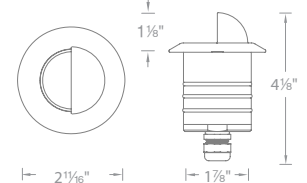
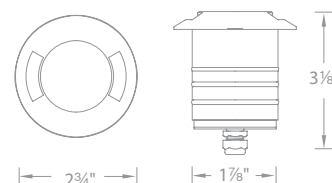
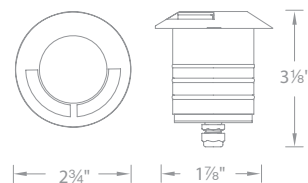
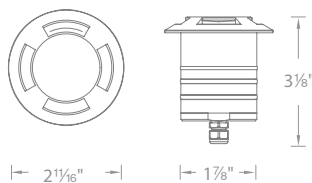

Input	Power	Brightness	Beam Angle	Color Temp	CRI	Rated Life
9-15VAC	4.1W / 6.6VA	Up to 245 lm	30° (When an open top is used)	2700K, 3000K	85	70,000 hours

*Optional spring clip accessory included. 6' Lead Wire included.

Accessories

2" Concrete Pour Kit

2000-CON-PVC

Transformer Required (order separately)
See Accessories page for more detail

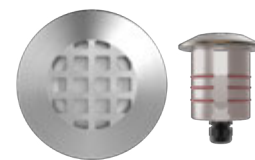

2" Louver

2121-27	BS
2121-30	SS

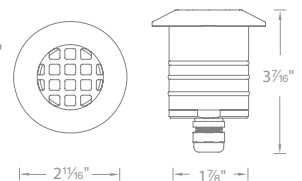

Includes stainless steel easy mount accessory
for use with underwater applications and
above ground on any surface



Designed for underwater or wet application
30ft long lead wire

**SUBMERSIBLE 2" INGROUND
LANDSCAPE**



SUBMERSIBLE 2" INGROUND LANDSCAPE

- Constant output for 9V-15V input
- 100%-10% dimming - see specification sheet for list of tested dimmers
- May be used in conjunction with all WAC® Landscape Lighting products
- Includes a detachable stainless steel mounting bracket for use in or out of water
- Solid stainless steel construction
- Factory sealed water tight fixtures
- 30' long lead wire



Ordering Chart

12V

2031-30

Fixture Finish Options:

SS Stainless Steel

Example: **2031-30SS**

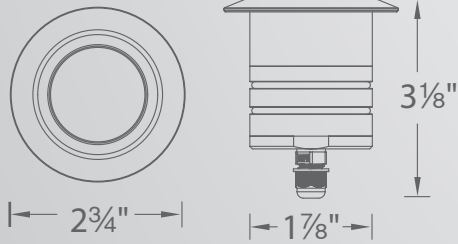

Input	Power	Brightness	Beam Angle	Color Temp	CRI	Rated Life
9-15VAC	4.1W / 6.6VA	245 lm	25°	3000K	85	70,000 hours

Transformer Required (order separately)

UNDERWATER SPOT LANDSCAPE



- Machined brass thumb screws
- Cast brass construction
- Underwater in depths up to 3'
- Factory sealed watertight fixtures
- 30' long lead wire
- Limited lifetime warranty

Ordering Chart

12V	Fixture Finish Options:
5511-30	NB Natural Brass
Example: 5511-30NB	

Input	Power	Brightness	Beam Angle	Color Temp	CRI	Rated Life
12-15VAC	10W/11.2VA	780 lm	60°	3000K	85	50,000 hours

Accessories Submersible luminaire

Optics Direct Burial Waterproof Wire Nuts

- LENS-20-AMB**
 - LENS-20-GRN**
 - LENS-20-RED**
 - LENS-20-BLU**
 - LENS-20-FR**
 - LENS-20-SPR**
- 9020-WNT-BK**

Detachable shroud and direct burial gel filled wire nuts (12V)
Transformer Required (order separately)
See Accessories page for more detail

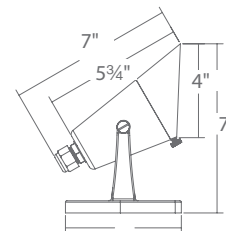
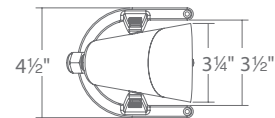



UNDERWATER SPOT
LANDSCAPE

TREE LIGHTS

LED LIGHT



Continuously Adjustable Beam Angles
Indexed at 35°, 45°, 55°



Select Warm White, Pure White, or Cool
White (2700K, 3000K or 4000K)



Continuously Adjustable Brightness

TREE LIGHTS LED LIGHT



Ordering Chart

12V	Pendant	12V	Pendant	12V	Ceiling Mount
3811-27/30/40	BK BZ	3821-27/30/40	BK BZ	3831-27/30/40	BK BZ WT*

3811/3821: 6' Chain included

Fixture Finish Options:

- BK** Black on Aluminum
- BZ** Bronze on Aluminum
- WT*** White on Aluminum

*WT finish available for 3831 model only

Example: **3831-27/30/40WT**

Accessories

- Optics
- LENS-11-AMB**
 - LENS-11-GRN**
 - LENS-11-RED**
 - LENS-11-BLU**
 - LENS-11-FR**

3821



3811



3831

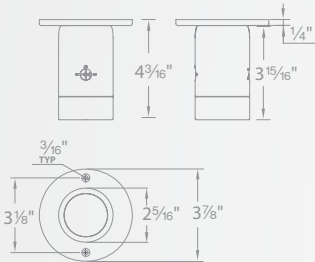

3831



Matching Ceiling Mount

Input	Power	Brightness	CCT	CRI	Rated Life
9-15VAC	1W - 7.5W 2VA - 8VA	45lm - 380lm	2700K, 3000K 4000K	85	50,000 hours

Transformer Required (order separately)

3821

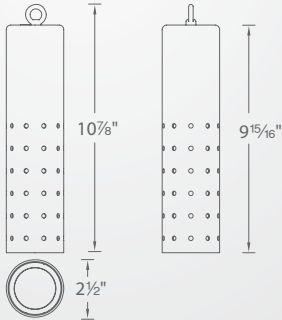

3811

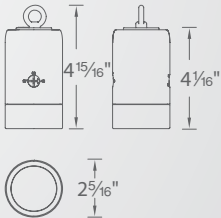

CYLINDER WALL MOUNT

PATENTED



Ordering Chart

12V

3611-27/30/40

Example: **3611-27/30/40BZ**

Fixture Finish Options:

BK	Black on Aluminum
BZ	Bronze on Aluminum
WT	White on Aluminum

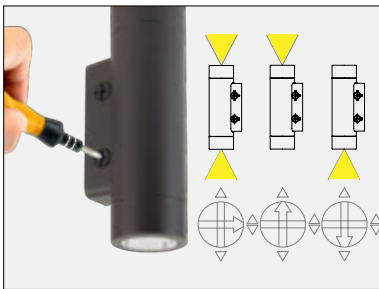
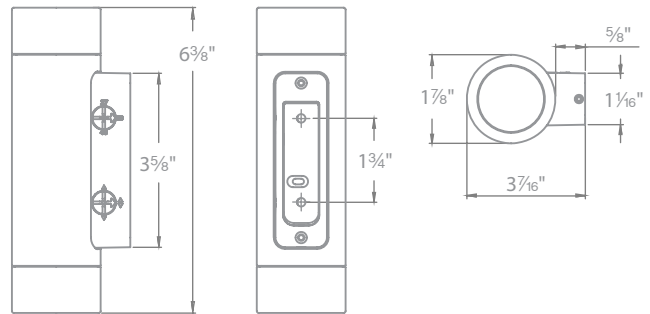

Select Up Light, Down Light or Both



Continuously Adjustable Beam Angles Indexed at 35°, 45°, 55°



Select Warm White, Pure White, or Cool White (2700K, 3000K or 4000K)

Input	Power	Brightness	Color Temp	CRI	Rated Life
9-15V	7.5W / 9.0VA	325 lm per light	2700K, 3000K, 4000K	85	50,000 hours

Accessories

Optics

LENS-11-AMB	LENS-11-RED	LENS-11-FR
LENS-11-GRN	LENS-11-BLU	

Transformer Required (order separately)

See Accessories page for more detail



CYLINDER
WALL MOUNT



Select Warm White (2700K) or Pure White (3000K) light



PATENTED QUICK RELEASE

Based on popular demand, our new patented invention allows for a watertight male/female connection at the fixture for ease of replacement after it is installed



Continuously adjustable brightness



Removable stainless steel capstone bracket and rotating mounting clips included

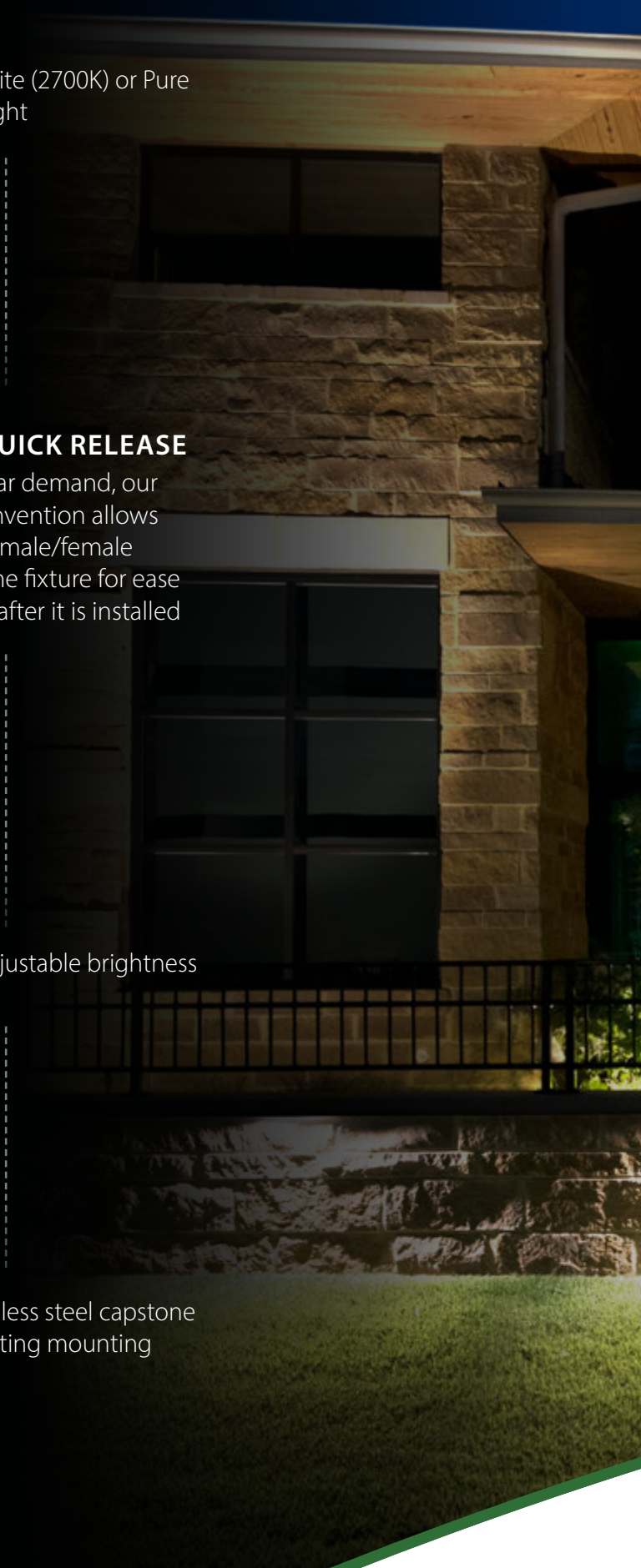



HARDSCAPE

Never pop a capstone again. Place low-profile Hardscape Lighting under the cap of stone walls to highlight the beautiful texture of stone at night. This patented hardscape light offers field serviceable quick-release mounting, selectable 2700K or 3000K CCT, and an integral brightness control dial.

- Quick Release connection at fixture to easily detach from capstone bracket after installation
- Integral Brightness control
- Select Color Temperature in the field
- Corrosion-resistant aluminum alloy
- Factory-sealed watertight fixture

- Tightly spaced and diffused LEDs for even illumination
- 6' lead wire and direct burial gel filled wire nuts included
- Easily serviceable, switch warm to pure white, and onboard dimming

Ordering Chart

18"	12"	6"	3"
7182-27/30	7122-27/30	7062-27/30	7032-27/30

Fixture Finish Options:

BK	Black on Aluminum
BZ	Bronze on Aluminum
BBR*	Bronze on Brass
GH	Graphite on Aluminum
SD	Sand on Aluminum

Example: **7182-27/30SD**

See photometric data on page 128

*BBR finish available for 7062 and 7122 model only



7182-27/30 18 inches



7122-27/30 12 inches



7062-27/30 6 inches

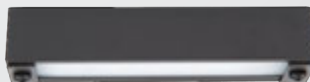

7032 3 inches

	Input	Power	Brightness	Beam Angle	CRI	Color Temp	Rated Life
18"	9 - 15VAC	8.5W, 9.3VA	350lm	110°	85	2700K, 3000K	70,000 hours
12"	9 - 15VAC	7.0W, 7.6VA	230lm	110°	85	2700K, 3000K	70,000 hours
6"	9 - 15VAC	4.5W, 5.6VA	110lm	110°	85	2700K, 3000K	70,000 hours
3"	9 - 15VAC	1.5W, 2.6VA**	50lm	110°	85	2700K, 3000K**	70,000 hours

**Due to its compact size, the 7032 is dedicated in either 2700K or 3000K

**No integral brightness control for 7032 model
Transformer Required (order separately)

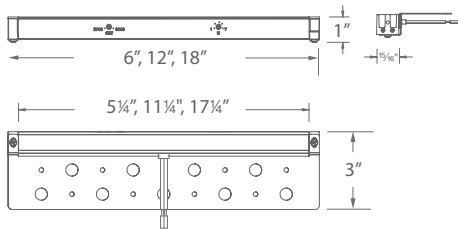

7062, 7122, 7182

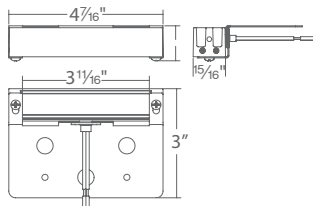

7032**



**HARDSCAPE
LANDSCAPE**





PATH & AREA

Sleek modern and traditional classic style Path and Area Lights conveniently fit within existing 12V landscape lighting systems. Constructed from corrosion-resistant brass and watertight aluminum bodies to withstand the elements in coastal environments.

LINEAR PATH LIGHT

IP67  1838 listed



- Integral brightness control
- Low profile and discreet
- 180° fully rotatable fixture aiming
- Lock desired position in place after adjustment
- Wide Flood Beam 110° x 80°
- Adjustable anti-glare shroud
- Designed for soft ground, wood floor and concrete
- Base mount, riser mount & extension mount
- Path & Accent applications

Ordering Chart

12V

6401-27
6401-30

Fixture Finish Options:

BK Black on Aluminum
BZ Bronze on Aluminum

Example: **6401-27BK**



On-Board Dimming Knob

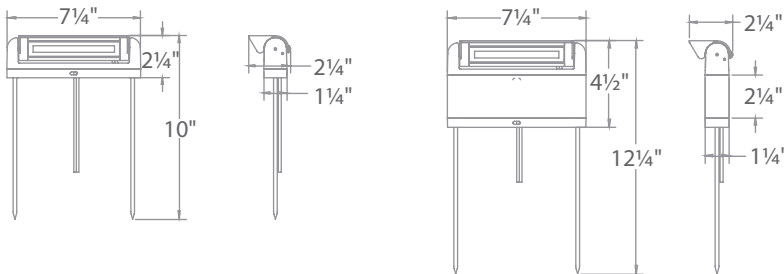

Optional riser attachment included



Extension mount included
(Order extension rods separately)

Input	Power	Brightness	Beam Angle	Color Temp	CRI	Rated Life
9-15VAC	1W - 6W 1.3VA - 8.6VA	65lm-190lm	110° x 80°	2700K, 3000K	85	60,000 hours

Accessories

9" Mounting Stake

9000-ST9-BZ

Extension Rods

5000-X04-BZ,BK
5000-X08-BZ,BK
5000-X12-BZ,BK
5000-X18-BZ,BK
5000-X24-BZ,BK

Detachable shroud, 10' lead wire and direct burial gel filled wire nuts included.

Transformer Required (order separately)

See Accessories page for more detail



LINEAR PATH LIGHT
LANDSCAPE

Input	Power	Brightness	Color Temp	CRI	Rated Life
9 - 15VAC	2.5W - 2.7VA	Up to 100lm	2700K, 3000K	90	60,000 hours

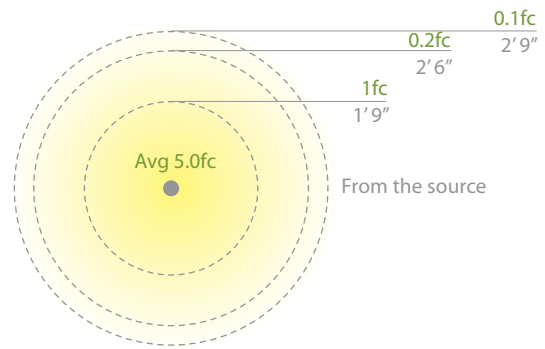

INTERPATH
AREA LIGHT

c **UL** us
1838 listed

 IP66

INTERPATH AREA LIGHT

- Simple design with small form factor, natural fit to any landscape
- Sturdy center mount design works well in applications where area illumination is desired
- Recommended spacing for installation:
Residential: 4 to 6ft
Commercial: 3 to 4ft



6511

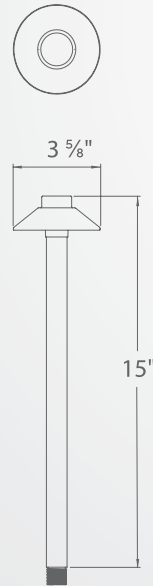

6521

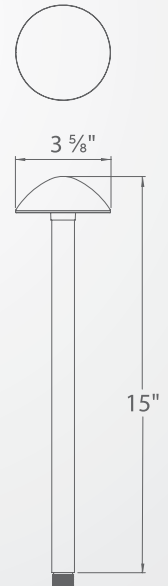

Ordering Chart

12V

6511-27
6511-30

6521-27
6521-30

Fixture Finish Options:

BK Black on Aluminum
BZ Bronze on Aluminum
BBR* Bronze on Brass

*BBR finish available for 6511 model only

Example: **6511-27BBR**

Accessories

9" Mounting Stake	14" Mounting Stake	Surface Mount Flange/Stake	Guardian Mount
9000-ST9-BZ	9000-ST14-BZ	5000-SCP-BK 5000-SCP-BZ 5000-SCP-BBR	9000-SP9-BZ

Transformer Required (order separately)

TIKI AREA LIGHT

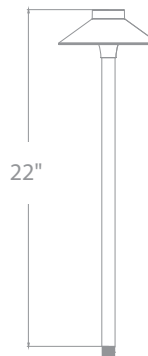
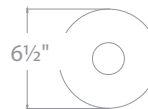
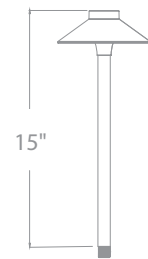
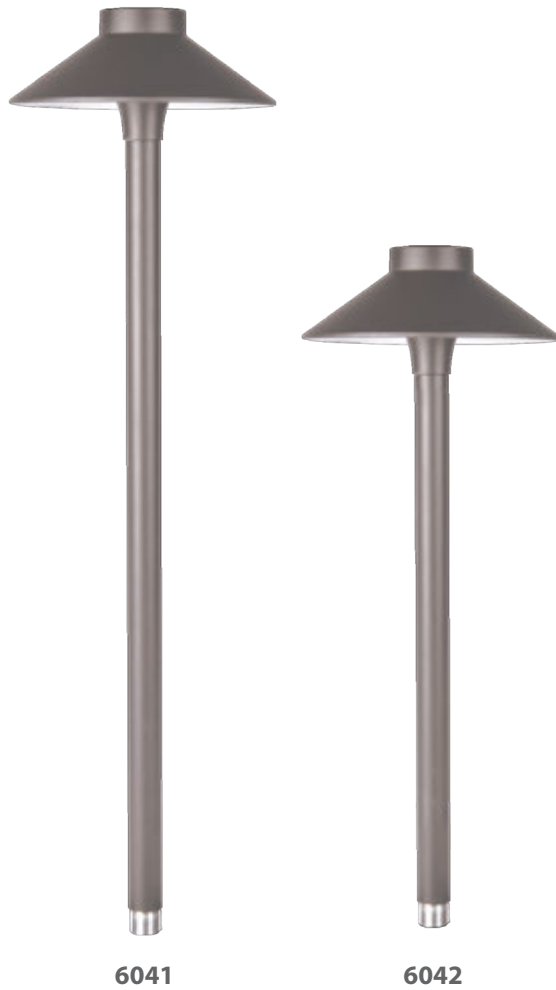

- Sturdy center mount design works well in applications where area illumination is desired
- Recommended spacing for installation:
Residential: 7 to 9ft
Commercial: 5 to 7ft
- Factory sealed, watertight fixtures
- Solid brass or corrosion resistant aluminum alloy
- Constant output for 9V-15V input

6041

6042

Ordering Chart

15"	22"
6042-27 6042-30	6041-27 6041-30

Fixture Finish Options:

BK	Black on Aluminum
BZ	Bronze on Aluminum
BBR**	Bronze on Brass

Example: **6042-27BZ**

Input	Power	Brightness	Color Temp	CRI	Rated Life
9-15VAC	6.5W / 9.5VA	Up to 225lm	2700K, 3000K	90	60,000 hours

Accessories

9" Mounting Stake	14" Mounting Stake	Surface Mount Flange/Stake	Guardian Mount
9000-ST9-BZ	9000-ST14-BZ	5000-SCP-BK 5000-SCP-BZ 5000-SCP-BBR	9000-SP9-BZ

9" Mounting stake, 6 foot lead wire, and direct burial gel filled wire nuts included
Transformer Required (order separately)
See Accessories page for more detail
**BBR finish available for 6041 model only

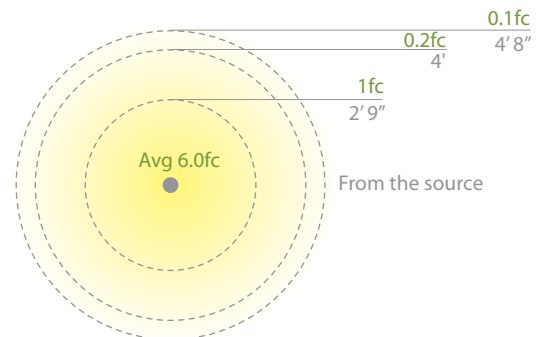
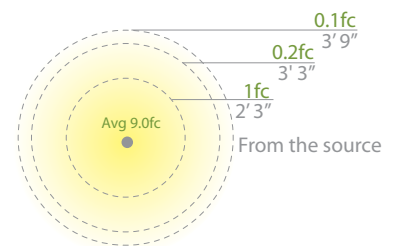



CANOPY AREA LIGHT

- Sturdy center mount design works well in applications where area illumination is desired
- Recommended spacing for installation:
Residential: 7 to 9ft
Commercial: 5 to 7ft
- Factory sealed, watertight fixtures
- Solid brass or corrosion resistant aluminum alloy
- Constant output for 9V-15V input



Ordering Chart

8" Cap	6" Cap	Fixture Finish Options:	
6051-27	6053-27	BK	Black on Aluminum
6051-30	6053-30	BZ	Bronze on Aluminum
		BBR	Bronze on Brass

Example: **6051-27BBR**

Input	Power	Brightness	Color Temp	CRI	Rated Life
9-15VAC	6.5W / 9.5VA	Up to 225lm	2700K, 3000K	90	60,000 hours

Accessories

9" Mounting Stake	14" Mounting Stake	Surface Mount Flange/Stake	Guardian Mount
9000-ST9-BZ	9000-ST14-BZ	5000-SCP-BK 5000-SCP-BZ 5000-SCP-BBR	9000-SP9-BZ

Mounting stake, 6 foot lead wire, and direct burial gel filled wire nuts included
Transformer Required (order separately)
See Accessories page for more detail

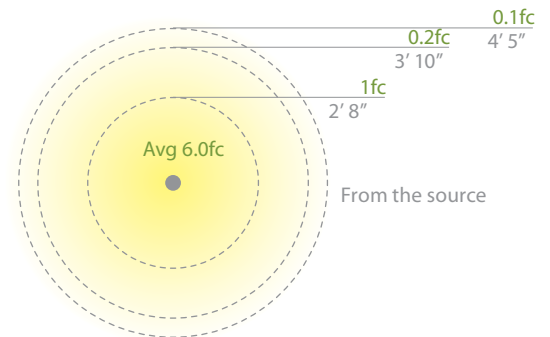

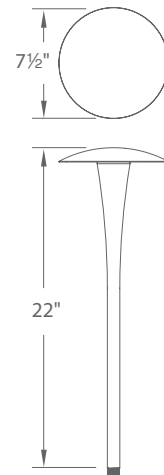

- Broad appeal makes this fixture suitable for varying landscape designs
- Recommended spacing for installation :
Residential: 11 to 13ft
Commercial: 7 to 9ft
- IP66 Rated, protected against high-pressure water jets
- Factory sealed, watertight fixtures
- Solid brass or corrosion resistant aluminum alloy
- Constant output for 9V-15V input

Ordering Chart

12V	Fixture Finish Options:	
6011-27	BK	Black on Aluminum
6011-30	BZ	Bronze on Aluminum
	BBR	Bronze on Brass

Example: **6011-27BZ**

Input	Power	Brightness	Color Temp	CRI	Rated Life
9-15VAC	5.8W / 9.4VA	Up to 150lm	2700K, 3000K	90	60,000 hours

Accessories

9" Mounting Stake	14" Mounting Stake	Surface Mount Flange/Stake	Guardian Mount
9000-ST9-BZ	9000-ST14-BZ	5000-SCP-BK 5000-SCP-BZ	9000-SP9-BZ

Mounting stake, 6 foot lead wire, and direct burial gel filled wire nuts included
Transformer Required (order separately)
See Accessories page for more detail

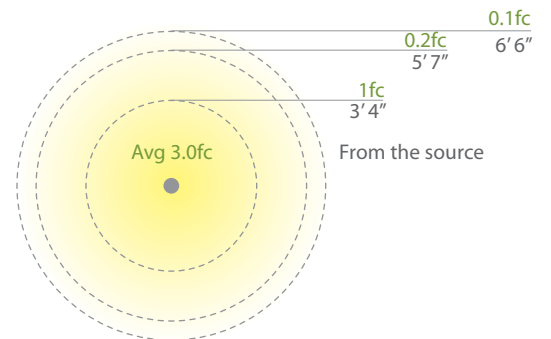

- Sleek linear design blends seamlessly into pathways while providing soft, even illumination
- Recommended spacing for installation:
Residential: 8 to 10ft
Commercial: 5 to 7ft
- Factory sealed, watertight fixtures
- Constant output for 9V-15V input

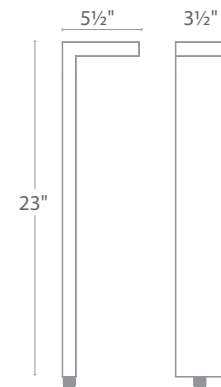

Ordering Chart

12V	Fixture Finish Options:
6081-27	BK Black on Aluminum
6081-30	BZ Bronze on Aluminum

Example: **6081-27BZ**

Input	Power	Brightness	Color Temp	CRI	Rated Life
9-15VAC	3.0W / 4.5VA	Up to 105lm	2700K, 3000K	90	60,000 hours

Accessories

9" Mounting Stake	14" Mounting Stake	Surface Mount Flange/Stake	Guardian Mount
9000-ST9-BZ	9000-ST14-BZ	5000-SCP-BK 5000-SCP-BZ 5000-SCP-BBR	9000-SP9-BZ

14" Mounting stake, 6 foot lead wire, and direct burial gel filled wire nuts included
Transformer Required (order separately)
See Accessories page for more detail

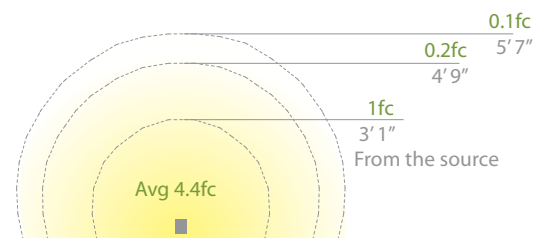

SLIDE PATH



- Sleek linear design blends seamlessly into pathways while providing soft, even illumination
- Factory sealed, watertight fixtures
- Constant output for 9V-15V input

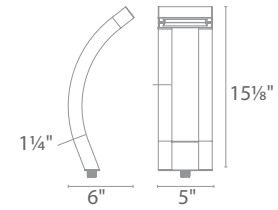

6311



6311



6321

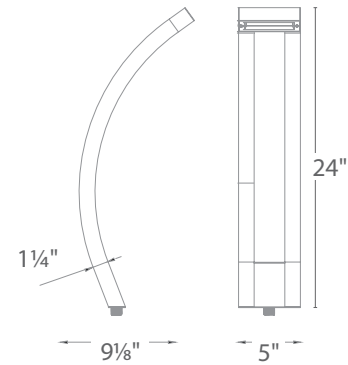

6321

Ordering Chart

Small	Large	Fixture Finish Options:	
6311-30	6321-30	BZ	Bronze on Aluminum
Example: 6311-30BZ			

Input	Power	Brightness	Color Temp	CRI	Rated Life
9-15VAC	3.0W / 4.5VA	Up to 95lm	3000K Pure white	90	60,000 hours

Accessories

9" Mounting Stake	14" Mounting Stake	Surface Mount Flange/Stake	Guardian Mount
9000-ST9-BZ	9000-ST14-BZ	5000-SCP-BK 5000-SCP-BZ 5000-SCP-BBR	9000-SP9-BZ

14" Mounting stake, 6 foot lead wire, and direct burial gel filled wire nuts included
Transformer Required (order separately)
See Accessories page for more detail

Recommended spacing for installation

6311 Small

- Residential: 7 to 9ft
- Commercial: 4 to 6ft

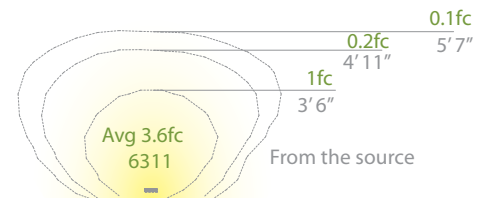

Recommended spacing for installation

6321 Large

- Residential: 9 to 11ft
- Commercial: 5 to 7ft

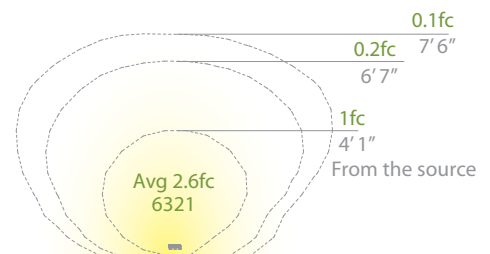



SLIDE
PATH

BALANCE SINGLE PATH

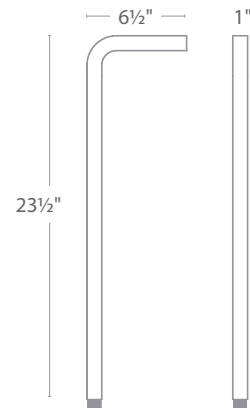

- Sleek linear design blends seamlessly into pathways while providing soft, even illumination
- Recommended spacing for installation :
Residential: 11 to 13ft
Commercial: 7 to 9ft
- Factory sealed, watertight fixtures
- Constant output for 9V-15V input

Ordering Chart

12V	Fixture Finish Options:	
6061-27	BK	Black on Aluminum
6061-30	BZ	Bronze on Aluminum

Example: **6061-27BZ**

Input	Power	Brightness	Color Temp	CRI	Rated Life
9-15VAC	6.5W / 11.5VA	Up to 275lm	2700K, 3000K	90	60,000 hours

Accessories			
9" Mounting Stake	14" Mounting Stake	Surface Mount Flange/Stake	Guardian Mount
9000-ST9-BZ	9000-ST14-BZ	5000-SCP-BK 5000-SCP-BZ	9000-SP9-BZ

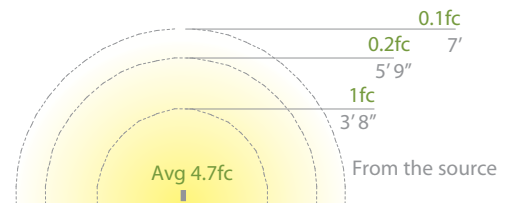

9" Mounting stake, 6 foot lead wire, and direct burial gel filled wire nuts included
Transformer Required (order separately)
See Accessories page for more detail



BALANCE DOUBLE PATH



- Sleek linear design blends seamlessly into pathways while providing soft, even illumination
- Recommended spacing for installation:
Residential: 11 to 13ft
Commercial: 7 to 9ft
- Factory sealed, watertight fixtures
- Constant output for 9V-15V input

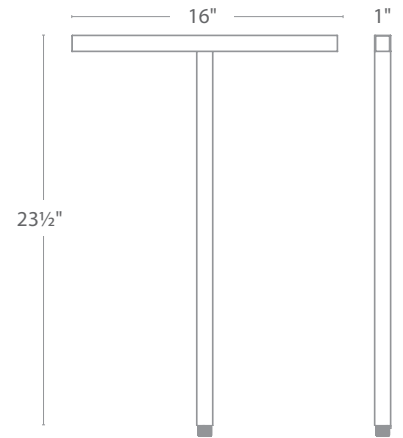

Ordering Chart

12V	Fixture Finish Options:	
6071-27	BK	<i>Black on Aluminum</i>
6071-30	BZ	<i>Bronze on Aluminum</i>
Example: 6071-27BZ		

Input	Power	Brightness	Color Temp	CRI	Rated Life
9-15VAC	10W / 14VA	Up to 375lm	2700K, 3000K	90	60,000 hours

Accessories

9" Mounting Stake	14" Mounting Stake	Surface Mount Flange/Stake	Guardian Mount
9000-ST9-BZ	9000-ST14-BZ	5000-SCP-BK 5000-SCP-BZ	9000-SP9-BZ

9" Mounting stake, 6 foot lead wire, and direct burial gel filled wire nuts included
Transformer Required (order separately)
See Accessories page for more detail

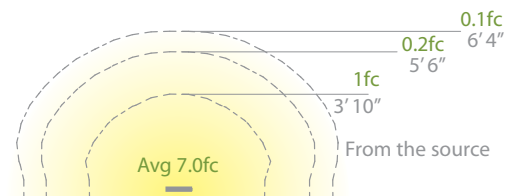

QUAD PATH



- Sleek linear design blends seamlessly into pathways while providing soft, even illumination
- Recommended spacing for installation :
Residential: 8 to 10ft
Commercial: 5 to 7ft
- Factory sealed, watertight fixtures
- Constant output for 9V-15V input

Ordering Chart

12V	Fixture Finish Options:
6091-27	BZ Bronze on Aluminum
6091-30	
Example: 6091-27BZ	

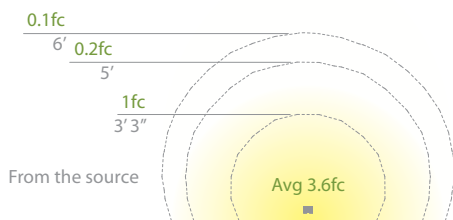
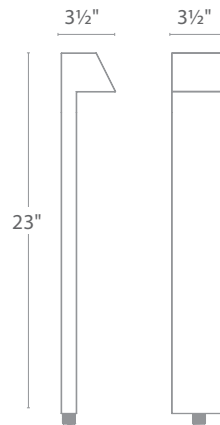

Input	Power	Brightness	Color Temp	CRI	Rated Life
9-15VAC	3W / 4.5VA	Up to 100lm	2700K, 3000K	90	60,000 hours

Accessories

9" Mounting Stake	14" Mounting Stake	Surface Mount Flange/Stake	Guardian Mount
9000-ST9-BZ	9000-ST14-BZ	5000-SCP-BK 5000-SCP-BZ	9000-SP9-BZ

14" Mounting stake, 6 foot lead wire, and direct burial gel filled wire nuts included
Transformer Required (order separately)
See Accessories page for more detail

- Sturdy side mount design works well in applications where directional illumination is desired
- Recommended spacing for installation :
Residential: 8 to 10ft
Commercial: 5 to 7ft
- Factory sealed, watertight fixtures
- Solid die-cast corrosion resistant aluminum alloy
- Constant output for 9V-15V input

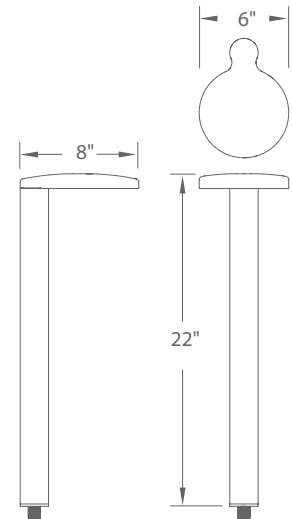

Ordering Chart

12V	Fixture Finish Options:	
6031-27	BK	Black on Aluminum
6031-30	BZ	Bronze on Aluminum

Example: **6031-27BK**

Input	Power	Brightness	Color Temp	CRI	Rated Life
9-15VAC	2.9W / 4.7VA	Up to 125lm	2700K, 3000K	90	60,000 hours

Accessories

9" Mounting Stake	14" Mounting Stake	Surface Mount Flange/Stake	Guardian Mount
9000-ST9-BZ	9000-ST14-BZ	5000-SCP-BK 5000-SCP-BZ	9000-SP9-BZ

14" Mounting stake, 6 foot lead wire, and direct burial gel filled wire nuts included
Transformer Required (order separately)
See Accessories page for more detail

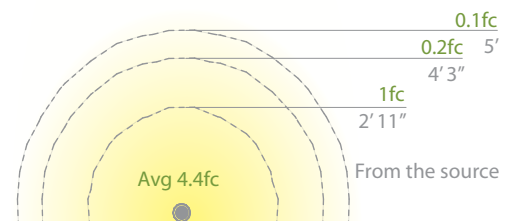

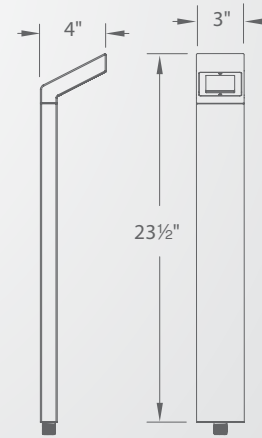

- Sleek linear design blends seamlessly into pathways while providing soft, even illumination
- Recommended spacing for installation :
Residential: 7 to 9ft
Commercial: 4 to 6ft
- Factory sealed, watertight fixtures
- Constant output for 9V-15V input

Ordering Chart

12V

6021-27
6021-30

Fixture Finish Options:

BK Black on Aluminum
BZ Bronze on Aluminum

Example: **6021-27BZ**

Input	Power	Brightness	Color Temp	CRI	Rated Life
9-15VAC	2.9W / 4.7VA	Up to 95lm	2700K, 3000K	90	60,000 hours

Accessories

9" Mounting Stake	14" Mounting Stake	Surface Mount Flange/Stake	Guardian Mount
9000-ST9-BZ	9000-ST14-BZ	5000-SCP-BK 5000-SCP-BZ	9000-SP9-BZ

14" Mounting stake, 6 foot lead wire, and direct burial gel filled wire nuts included
Transformer Required (order separately)
See Accessories page for more detail

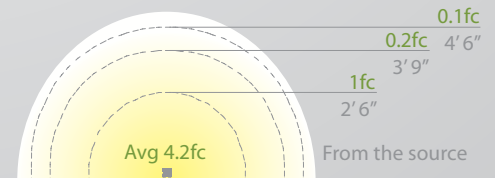



BOLLARD

Improve visibility in low-light areas with powerful LED Bollards. With an aluminum construction and factory-sealed water-tight body, the bollards stand up to the elements and high-pressure water jets. Use an array to illuminate paths and walkways to maximize nighttime visibility and safety.

GATE BOLLARD/PATH



- Factory sealed, watertight fixtures
- Constant output for 9V-15V input
- Mounting accessories included
- Detachable back plate for lighting control included



Shown without plate Shown with plate

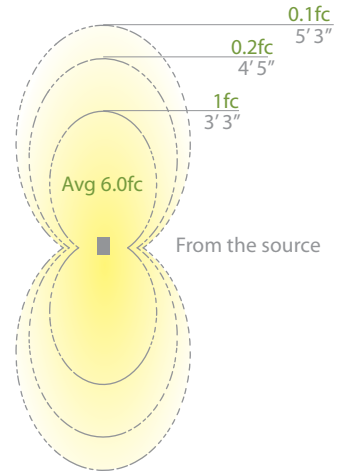

Ordering Chart

12V	Fixture Finish Options:
6651-27	BK Black on Aluminum
6651-30	BZ Bronze on Aluminum

Example: **6651-27BK**

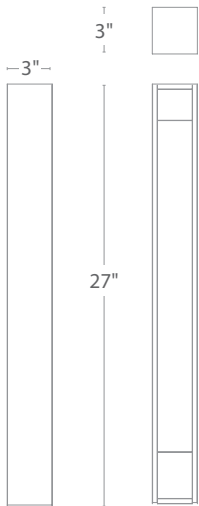

Mounting accessory included
12V



M6000-STAKE



Single direction illumination with back plate

Input	Power	Brightness	Color Temp	CRI	Rated Life
9-15VAC	7.2W / 7.6VA	115lm	2700K, 3000K	90	60,000 hours

Power stake, 6 foot lead wire, and direct burial gel filled wire nuts included
Transformer Required (order separately)



GATE
BOLLARD/PATH

Recommended spacing for installation :
 (12V) 6611

- Residential: 5 to 6ft
- Commercial: 3 to 4ft

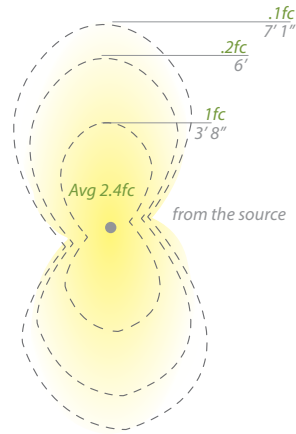

Recommended spacing for installation:
 (120V, 277V) 6612, 6613

- Residential: 6.5 to 7.5ft
- Commercial: 4.5 to 5.5ft

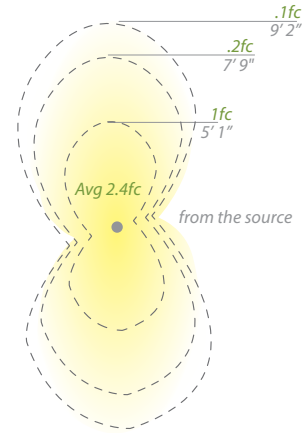

Mounting accessory included

12V

120V/277V



M6000-STAKE

M6610-CON-KIT



**SCOOP 12V/120V/277V
 BOLLARD**

Even illumination front and back



SCOOP 12V/120V/277V (CHECK VOLTAGE)

BOLLARD

- Sleek linear design blends seamlessly into pathways while providing soft, even illumination front and back
- Factory sealed, watertight fixtures
- Constant output for 9V-15V input
- Mounting accessories included

Ordering Chart

12V	120V	277V
6611-27	6612-27	6613-27
6611-30	6612-30	6613-30

Fixture Finish Options:

BK	Black on Aluminum
BZ	Bronze on Aluminum

Example: **6613-27BZ**

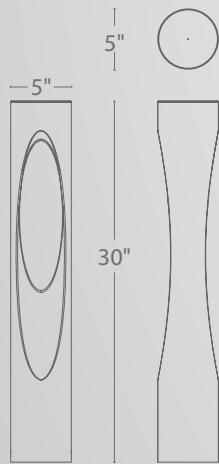

	Input	Power	Brightness	Color Temp	CRI	Dimming	Rated Life
12V	9-15VAC	7.8W / 8.5VA	Up to 180lm	2700K, 3000K	90	MLV only	60,000 hours
						Transformer Required (order separately)	
120V	120V	12.5W	Up to 350lm	2700K, 3000K	90	TRIAC or ELV	60,000 hours
277V	277V	13.2W	Up to 370lm	2700K, 3000K	90	ELV only	60,000 hours

CHAMBER 12V/120V/277V (CHECK VOLTAGE) BOLLARD



- Sleek linear design blends seamlessly into pathways while providing soft, even illumination
- Factory sealed, watertight fixtures
- Constant output for 9V-15V input

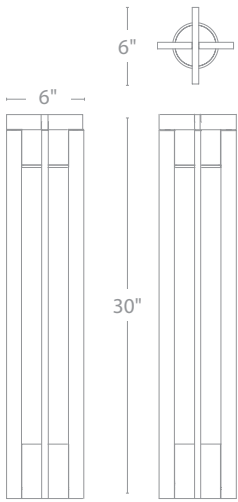

Recommended spacing for installation :
(12V) 6631

- Residential: 19.5 to 23ft
- Commercial: 13 to 15.5ft

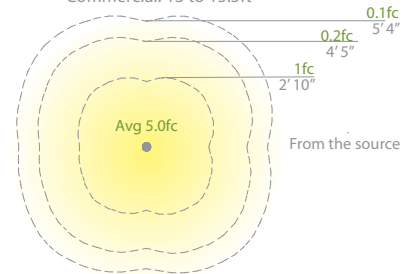

Recommended spacing for installation :
(120V, 277V) 6632, 6633

- Residential: 12.5 to 15ft
- Commercial: 8 to 10ft

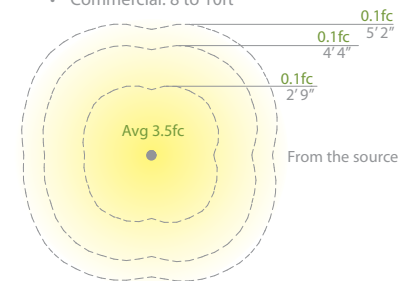

Ordering Chart

12V	120V	277V
6631-27	6632-27	6633-27
6631-30	6632-30	6633-30

Fixture Finish Options:

BK	Black on Aluminum
BZ	Bronze on Aluminum

Example: **6631-27BZ**

	Input	Power	Brightness	Color Temp	CRI	Dimming	Rated Life
12V	9-15VAC	5.8W / 6.2VA	Up to 150lm	2700K, 3000K	90	MLV only	60,000 hours
120V	120V	12.5W	Up to 400lm	2700K, 3000K	90	TRIAC or ELV	60,000 hours
277V	277V	13.2W	Up to 450lm	2700K, 3000K	90	ELV only	60,000 hours

Transformer Required (order separately)

Mounting accessory included



M6000-STAKE

M6630-CON-KIT



CHAMBER 12V/120V/277V
BOLLARD

CHAMBER 120V/277V (CHECK VOLTAGE) 16", 20" & 25" OUTDOOR WALL SCNCE

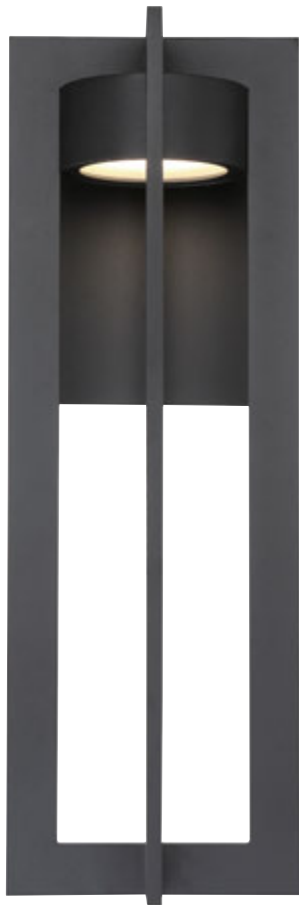

- Solid aluminum construction with weather-resistant finish
- Minimal mounting hardware for easy installation
- Light engine is factory sealed for maximum protection from the elements
- No transformer or driver required

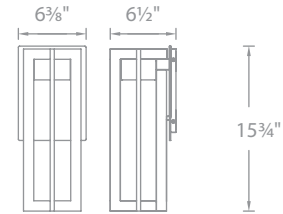

WS-W48616

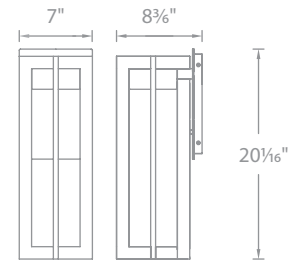

WS-W48620

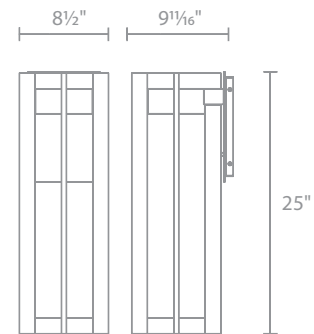

WS-W48625

Ordering Chart

Sconce

Fixture Finish Options:

WS-W48616
WS-W48620
WS-W48625

BK Black
BZ Bronze

Example: **WS-W48616-BK**

For 277V, add an "F" before the finish: **WS-W48616F-BK**

Bold Mid-Century Modern look with intersecting aluminum frames and cutting-edge LED light.

	Input	Power	Brightness	Color Temp	CRI	Dimming	Rated Life
16"	120V (277V special order)	12W	255lm	3000K	90	100% –10% ELV	50,000 hours
20"	120V (277V special order)	18W	519lm	3000K	90	100% –10% ELV	50,000 hours
25"	120V (277V special order)	22W	605lm	3000K	90	100% –10% ELV	50,000 hours



CHAMBER 120V/277V (CHECK VOLTAGE) 16" OUTDOOR PENDANT & 20" OUTDOOR POST MOUNT

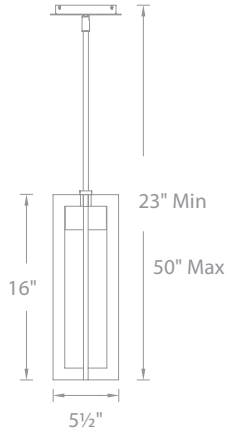

PD-W48616



PM-W48620

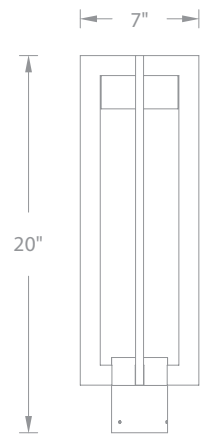

Ordering Chart

Pendant

PD-W48616

Post Mount

PM-W48620

Fixture Finish Options:

BK Black
BZ Bronze

Example: **PD-W48616-BK**

For 277V, add an "F" before the finish: **PD-W48616F-BK**

	Input	Power	Brightness	Color Temp	CRI	Dimming	Rated Life
16"	120V	12W	372lm	3000K	90	100% -10% ELV	50,000 hours
20"	120V (277V special order)	17.5W	634lm	3000K	90	100% -10% ELV	50,000 hours

Recommended spacing for installation :
(12V) 6621

- Residential: 12 to 14.5ft
- Commercial: 4 to 6.5ft

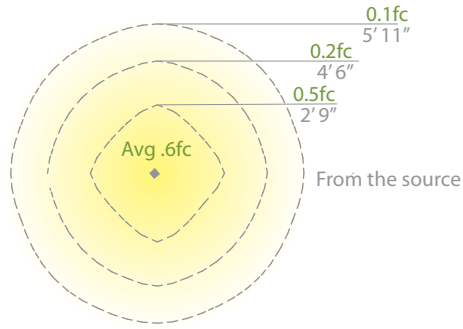

Recommended spacing for installation :
(120V, 277V) 6622, 6623

- Residential: 16 to 22ft
- Commercial: 8 to 11ft

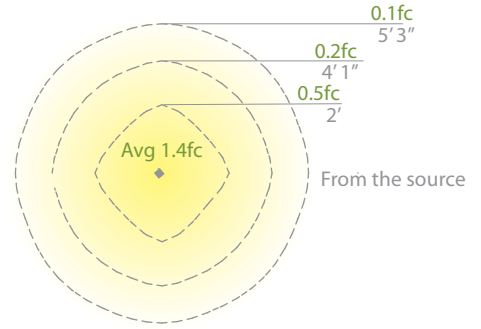

Mounting accessory included

12V

120V/277V



M6000-STAKE

M6620-CON-KIT



TOWER 12V/120V/277V
BOLLARD



TOWER 12V/120V/277V (CHECK VOLTAGE) BOLLARD

- Sleek linear design blends seamlessly into pathways while providing soft, even illumination
- Factory sealed, watertight fixtures
- Constant output for 9V-15V input
- Mounting accessories included

Ordering Chart

12V	120V	277V
6621-27	6622-27	6623-27
6621-30	6622-30	6623-30

Fixture Finish Options:

BK	Black on Aluminum
BZ	Bronze on Aluminum

Example: **6623-27BZ**



	Input	Power	Brightness	Color Temp	CRI	Dimming	Rated Life
12V	9-15VAC	5.8W / 6.2VA	Up to 170lm	2700K, 3000K	90	MLV only	60,000 hours
Transformer Required (order separately)							
120V	120V	12.5W	Up to 430lm	2700K, 3000K	90	TRIAC or ELV	60,000 hours
277V	277V	13.2W	Up to 470lm	2700K, 3000K	90	ELV only	60,000 hours

ARCHETYPE 12V/120V/277V (CHECK VOLTAGE)

BOLLARD



- Sleek linear design blends seamlessly into pathways while providing soft, even illumination



Recommended spacing for installation :
(12V) 6641

- Residential: 11.5 to 14ft
- Commercial: 7 to 9ft

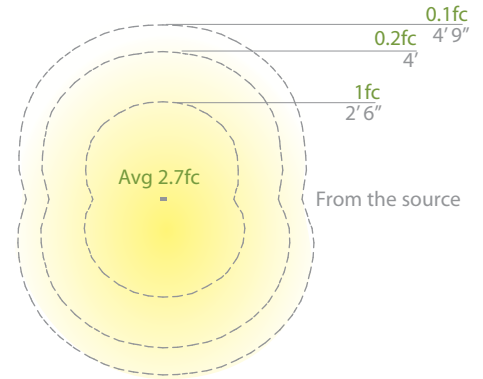

Recommended spacing for installation :
(120V, 277V) 6642, 6643

- Residential: 12.5 to 14.5ft
- Commercial: 8 to 9.5ft

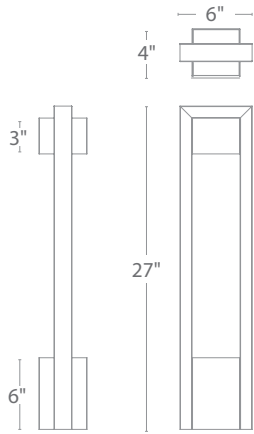
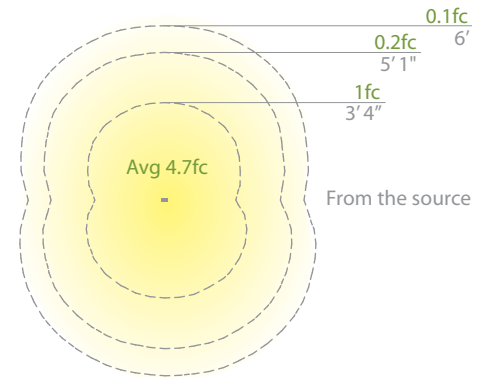

Ordering Chart

12V	120V	277V
6641-27	6642-27	6643-27
6641-30	6642-30	6643-30

Fixture Finish Options:

BK	Black on Aluminum
BZ	Bronze on Aluminum

Example: **6643-27BZ**

Mounting accessory included



M6000-STAKE **M6640-CON-KIT**

	Input	Power	Brightness	Color Temp	CRI	Dimming	Rated Life
12V	9-15VAC	5.8W / 6.2VA	Up to 195lm	2700K, 3000K	90	MLV only Transformer Required (order separately)	60,000 hours
120V	120V	12.5W	Up to 470lm	2700K, 3000K	90	TRIAC or ELV	60,000 hours
277V	277V	13.2W	Up to 550lm	2700K, 3000K	90	ELV only	60,000 hours



ARCHETYPE 12V/120V/277V
BOLLARD

ARCHETYPE 120V/277V

12", 18", & 24" OUTDOOR WALL SCNCE



A low-profile, artful design adds a distinctive, sophisticated look in any outdoor application.

- Aluminum hardware with etched glass diffuser
- No transformer or driver required

Ordering Chart

Scence

WS-W13918
WS-W13924

WS-W15912
WS-W15918
WS-W15924

Fixture Finish Options:

BK Black

Example: **WS-W13918-BK**

WS-W15912

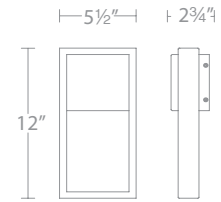

WS-W13918

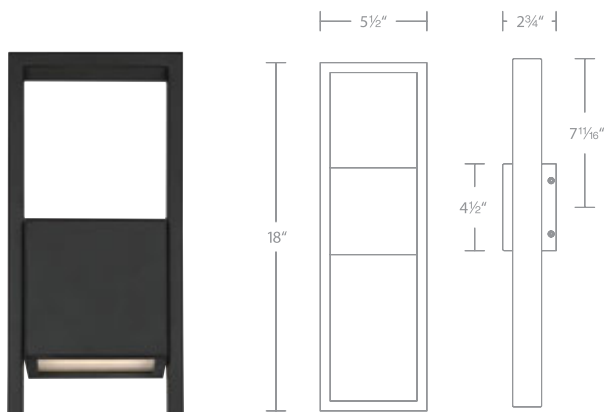

WS-W15918

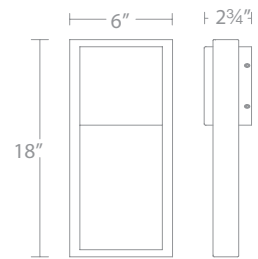

WS-W13924

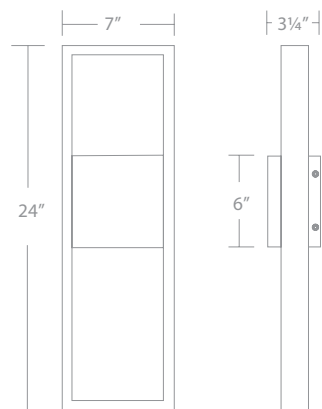

WS-W15924

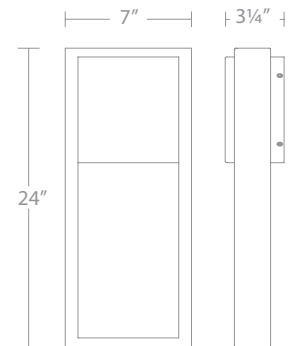

	Model	Input	Power	Brightness	Color Temp	CRI	Dimming	Rated Life
18"	WS-W13918	120V	16W	427lm	3000K	90	100% -10% ELV	54,000 hours
24"	WS-W13924	120V	22W	760lm	3000K	90	100% -10% ELV	54,000 hours
12"	WS-W15912	120V	10W	331lm	3000K	90	100% -10% ELV	54,000 hours
18"	WS-W15918	120V	13W	435lm	3000K	90	100% -10% ELV	54,000 hours
24"	WS-W15924	120V	16W	775lm	3000K	90	100% -10% ELV	54,000 hours

PENDANT

- Aluminum hardware with etched glass diffuser
- No transformer or driver needed
- Three 12" and one 6" downrod included (additional rods available)

POST MOUNT

- Aluminum hardware with etched glass diffuser
- No transformer or driver needed
- Mount on 3" maximum post (not included)

Ordering Chart

Pendant	Post Mount	Fixture Finish Options:	
PD-W15918	PM-W15928	BK	Black

Example: **PD-W15918-BK**

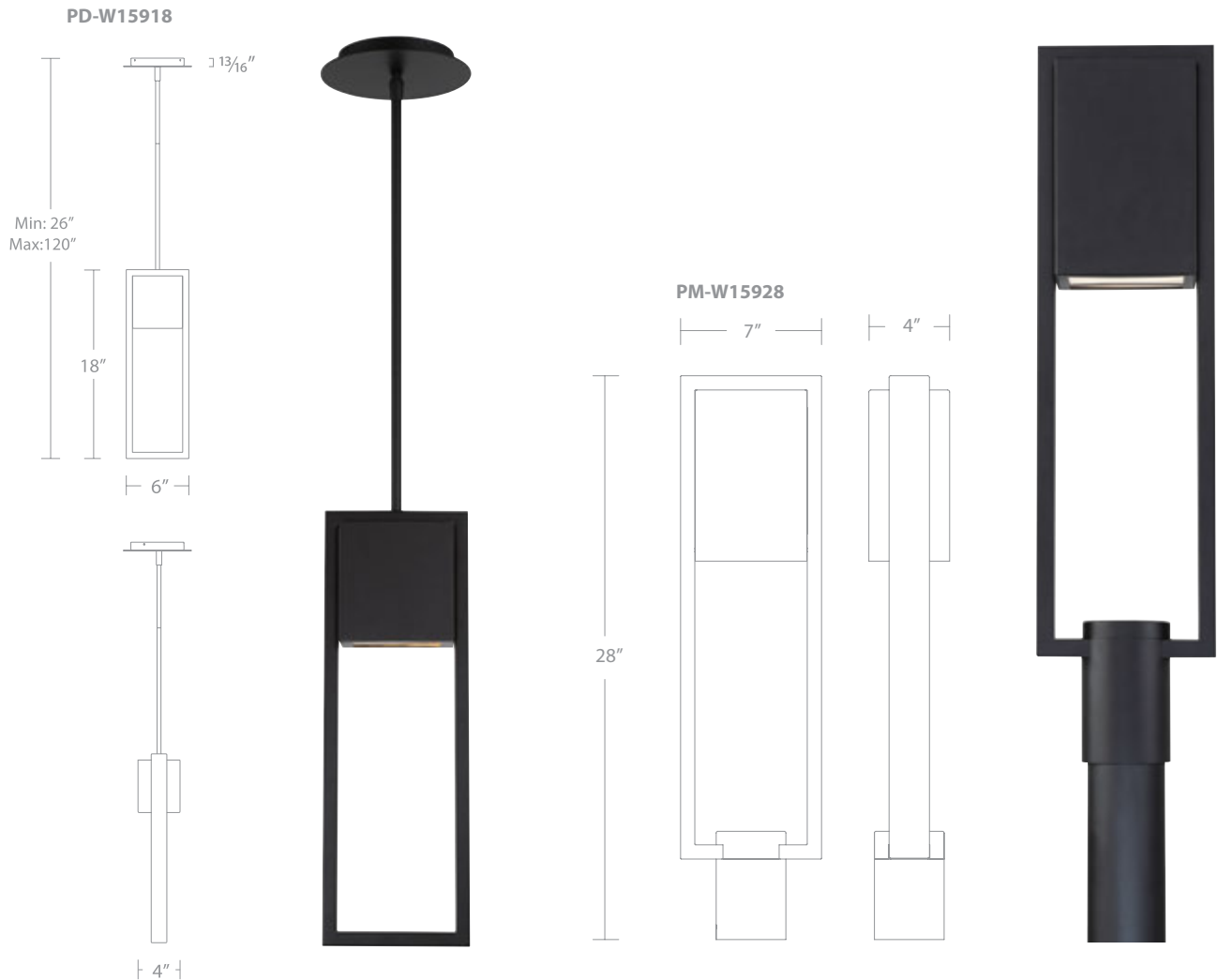

	Model	Input	Power	Brightness	Color Temp	CRI	Dimming	Rated Life
18"	PD-W15918	120V	10W	379	3000K	90	100% -10% ELV	54,000 hours
28"	PM-W15928	120V	16W	382	3000K	90	100% -10% ELV	54,000 hours





LANDSCAPE TAPE LIGHTING

Upgrade your outdoor areas with InvisiLED® outdoor series LED tape lights, perfect for large installations and compatible with traditional landscapes, offering a captivating lighting experience. Featuring smart technology integration, including wireless control via popular platforms, they allow easy scheduling and scene transitions. Durable and designed to withstand the elements, these lights enhance outdoor aesthetics with a spectacle of light and advanced technology.

12VAC OUTDOOR IP66 LANDSCAPE TAPE LIGHTING



- Seamless integration with standard magnetic transformers or landscape lighting
- COB technology ensures uniform, dot-free illumination
- Constructed with double-insulated, UV-stabilized silicone for durability
- Energy-efficient, consuming only 1.5W per foot while delivering 100 lumens per foot
- High color fidelity with a 90+ color rendering index
- Easy-to-use push-in connectors for simple, hassle-free installation
- Available in warm white tones of 2700K and 3000K
- Cutable every 2 inches with end-caps to maintain integrity
- Versatile spool lengths: 1ft, 5ft, 10ft, 20ft, and 35ft
- Compatible with MLV dimmers for adjustable brightness

Max Run Length

Total Length of Lead Wire Between Magnetic Transformer and Tape	With 5A Fuse Lead Wire
6ft	35ft
9ft	35ft
12ft	27ft
18ft	18ft
24ft	13ft
30ft	10ft
40ft	8ft

Ordering Chart

8012	1 foot	27 30
8052	5 feet	
8102	10 feet	
8202	20 feet	
8352	35 feet	

Fixture Finish:

WT White

Example: **8202-30WT**

Transformer Required (order separately)

Input	Power	Brightness	Color Temp	CRI	Rated Life	Cutting Length
12VAC	1.5W per foot	100 lm per foot	2700K, 3000K	90+	50,000 hours	2 inches

Accessories

Joiner Cable	Y Connector	X Connector	End Cap	5' Clear Channel	Lead Wire with 5A Fuse
T24-OD-IC6-WT T24-OD-IC12-WT T24-OD-IC72-WT T24-OD-IC120-WT	T24-OD-Y-WT	T24-OD-X-WT	T24-OD-EC-WT	T24-OD-CH5-CL	8002-06WT 8002-10WT

See Accessories page for more detail

Surface Mounting Clip	Edge Mounting Clip	Underside Mounting Clip
T24-OD-C1-WT	T24-OD-C2-WT	T24-OD-C3-WT

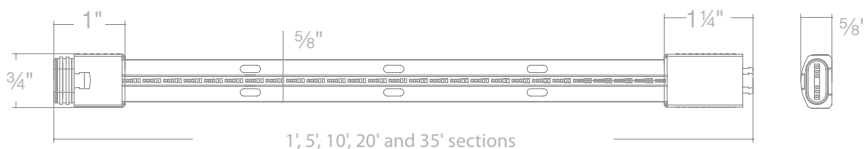



24VDC OUTDOOR NON-SUBMERSIBLE LANDSCAPE TAPE LIGHTING



- May be cut every 4 inches
- Beam Spread: 115°
- Multiple roll lengths offered
- Equal brightness from end to end
- Protection against water spray, dust with silicone jacket (IP65)
- 100 ft max distance between the power supply and beginning of InvisiLED®

Ordering Chart		Fixture Finish:	System	Max Run
	01	1 foot		
	05	5 feet		
T24-OD1	10	10 feet	T24-OD1	80ft
T24-OD2	20	20 feet	T24-OD2	40ft
	40	40 feet		
	80*	80 feet*		



*T24-OD2 not available in 80 feet

Example: **T24-OD2-01-27**

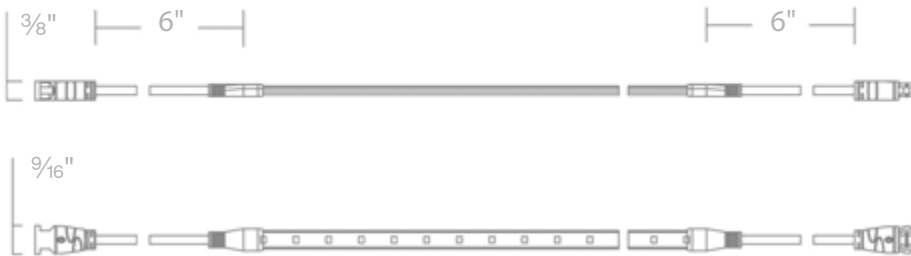

Input	Power	Brightness	Color Temp	CRI	Rated Life
24VDC	1.2W/ft	T24-OD1	2700K, 3000K, 4000K	90	50,000 hours
	2.4W/ft	T24-OD2	up to 200 lm per foot		





Power Supply for TRIAC/ELV Dimming

Model	Input	Output	Dimmable	
 PS-24DC-U96R-WE	120V-277VAC	24V DC 96W	ELV / TRIAC	Remote Wet Location Includes a 6 foot lead wire
 PS-24DC-A96P-WE	120V	24V DC 96W	N/A	Portable Wet Location Includes a 6 foot lead wire 120V input power cord ready

Power Supply for Wireless/DMX Control

	Model	Input	Output	Dimension	
	PS-24DC-U96R-IP67	120/277VAC	24VDC, 96W	8 3/8" x 2 13/16" x 1 1/16"	Remote Power Supply - Wet Location IP67 Class 2 Output Power Supply. Includes a 6 foot lead wire.
	PS-24DC-U96R-IP45	120/277VAC	24VDC, 96W	8 13/16" x 2 1/4" x 1 1/4"	Remote Power Supply - Damp Location IP45 Class 2 Output Power Supply. Includes a 6 foot lead wire.
	PS-24DC-A96P-OD	120VAC	24VDC, 96W	8 3/8" x 2 13/16" x 1 1/16"	Portable Power Supply - Wet Location IP67 Class 2 Output Power Supply. Includes a 6 foot lead wire.

Controller

	T24-OD-CTR	24VDC, 96W Max from power supply 3ft input cable included	24VDC, 90W Max 3ft output cable included	5" x 3 1/2" x 1 1/2"	Outdoor Wireless DMX Controller Allows outdoor tape to be wirelessly controlled through MyWAC app, WallStation, or DMX. IP65 wet rated *Wi-Fi network is required to operate the system. This controller consumes 6W power Max
	LED-WCT-WT	120-230VAC	N/A	4 5/8" x 2 3/4" x 1 5/8"	WallStation Multi-scene selection/Dimming Control, dedicated Off button/Suitable for standard single NEMA wall box Setup and configuration via MyWAC mobile application

Accessories

InvisLED Outdoor Joiner Cable	InvisLED Outdoor Lead Wire	InvisLED Outdoor Power Connector Kit with Wire Jacket and Silicone Sealant	InvisLED Outdoor Tape to Tape Y Connector	Wireless Controller to InvisLED Outdoor Tape joiner Cable	InvisLED Outdoor Surface Mount Clear Channel	Silicone Sealant
T24-WE-IC-002-BK T24-WE-IC-006-BK T24-WE-IC-012-BK T24-WE-IC-036-BK T24-WE-IC-072-BK T24-WE-IC-144-BK T24-WE-IC-240-BK	T24-WE-BO12-BK T24-WE-BO72-BK	T24-WE-EX2-006-BK	T24-WE-Y-BK	T24-WE-EX-CTR	T24-WE-CH5	T24-WE-SI-45
InvisLED Outdoor Edge Mounting Clip.	InvisLED Outdoor Surface Mounting Clip	InvisLED Outdoor Underside Mounting Clip.	Wet Rated Tape End Cap with Silicone Sealant	DMX Signal Cable - Universe	DMX Signal Cable - Satellite	
LED-TO24-C2	LED-TO24-C1	T24-WE-C3	T24-WE-EC	T24-OD-MW60 T24-OD-MW120	T24-OD-SW60 T24-OD-SW120	

See Accessories page for more detail

Example installation for Wireless and DMX control

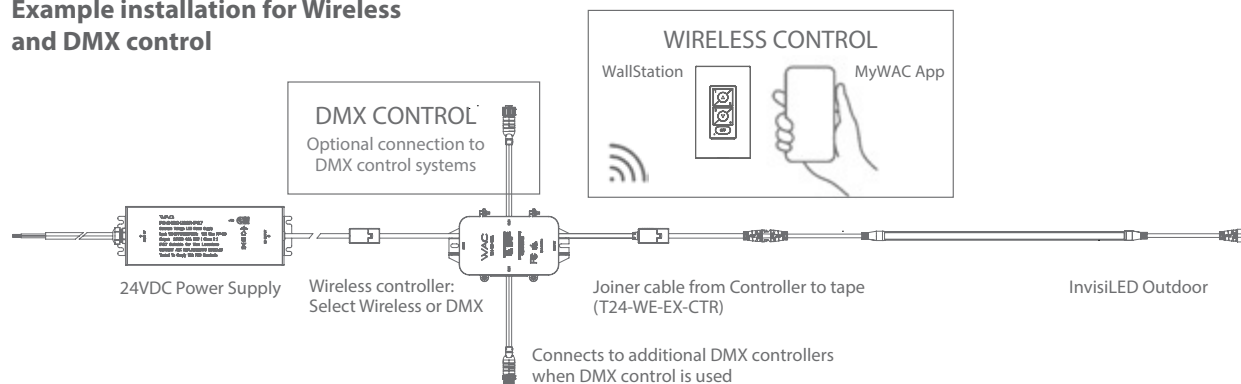

24VDC OUTDOOR PRO+

IP66 LANDSCAPE TAPE LIGHTING



- Weatherproof resilience for all conditions
- IP66 rated silicone jacket for outdoor durability
- High-intensity white LEDs with a CRI > 90
- Dual dimming options: traditional and wireless DMX control
- Easy-to-use push-in connectors for quick installation
- Smart system compatibility with MyWAC app and home assistants
- Varied lumens and lengths, customizable every 2 inches
- End caps provided for a neat finish after cutting
- Seamless and uniform illumination

Ordering Chart

	01	1 foot		
	05	5 feet	27P	2700K
T24-OD1	10	10 feet	30P	3000K
T24-OD2	20	20 feet	35P	3500K
	30*	30 feet	40P	4000K
	40**	40 feet**		

Fixture Finish:

White

* Only available in the T24-OD2 model

** Only available in the T24-OD1 model

Example: **T24-OD1-20-30P**

Input	Power	Brightness	Color Temp	CRI	Rated Life	Cutting Length
24VDC	1.2W/ft 2.3W/ft	T24-OD1 T24-OD2	up to 100 lm per foot up to 200 lm per foot	2700K, 3000K, 3500K, 4000K	90	50,000 hours 2 inches

Max Run Length

T24-OD1 (100lm/ft)



T24-OD2 (200lm/ft)

Total Length of Lead Wire from Power Supply/Controller to tape	T24-OD1 (100lm/ft)		T24-OD2 (200lm/ft)	
	TRIAC/ELV Dimming: Power Supply	Wireless Control: Power Supply + Wireless DMX Controller	TRIAC/ELV Dimming: Power Supply	Wireless Control: Power Supply + Wireless DMX Controller
6ft	40ft	40ft	30ft	30ft
9ft	40ft	40ft	30ft	26ft
12ft	40ft	38ft	26ft	22ft
18ft	33ft	29ft	20ft	17ft
24ft	26ft	24ft	16ft	14ft
30ft	22ft	20ft	13ft	12ft
40ft	17ft	16ft	10ft	9ft

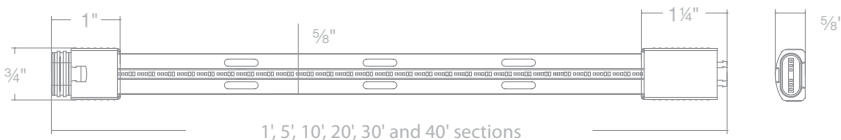

Note: Calculation based on 6' lead wire between power supply and controller



Power Supply

	Model	Input	Output	Dimension	Dimming	
	PS-24DC-U96R-IP67	120/277VAC	24VDC, 96W	8 3/8" x 2 13/16" x 1 11/16"	TRIAC/ELV	Remote Power Supply - Wet Location IP67 Class 2 Output Power Supply. Includes a 6 foot lead wire.
	PS-24DC-U96R-IP45	120/277VAC	24VDC, 96W	8 13/16" x 2 1/16" x 1 1/4"	TRIAC/ELV	Remote Power Supply - Damp Location IP45 Class 2 Output Power Supply. Includes a 6 foot lead wire.
	PS-24DC-A96P-OD	120VAC	24VDC, 96W	8 3/8" x 2 13/16" x 1 11/16"	N/A	Portable Power Supply - Wet Location IP67 Class 2 Output Power Supply. Includes a 6 foot lead wire.

Controller

	T24-OD-CTR	24VDC, 96W Max from power supply 3ft input cable included	24VDC, 90W Max 3ft output cable included	5" x 3 1/2" x 1 1/2"		Outdoor Wireless DMX Controller Allows outdoor tape to be wirelessly controlled through MyWAC app, WallStation, or DMX. IP65 wet rated *Wi-Fi network is required to operate the system. This controller consumes 6W power Max
	LED-WCT-WT	120-230VAC	N/A	4 5/8" x 2 3/4" x 1 5/8"		WallStation Multi-scene selection/Dimming Control, dedicated Off button/ Suitable for standard single NEMA wall box Setup and configuration via MyWAC mobile application

Important Dimming Notice: Must select either the Outdoor Wireless DMX Controller (T24-OD-CTR) for wireless operation or a TRIAC/ELV dimmer for dimming capabilities. Please be aware that these control options cannot be used simultaneously—the LED tape cannot be dimmed using both the TRIAC/ELV dimmer and wirelessly from the mobile app or WallStation. Choose one method to ensure optimal functionality and avoid operational conflicts.

Accessories

Joiner Cable	Y Connector	X Connector	End Cap	5' Clear Channel	Surface Mounting Clip	Edge Mounting Clip
T24-OD-IC6-WT T24-OD-IC12-WT T24-OD-IC72-WT T24-OD-IC120-WT	T24-OD-Y-WT	T24-OD-X-WT	T24-OD-EC-WT	T24-OD-CH5-CL	T24-OD-C1-WT	T24-OD-C2-WT
Underside Mounting Clip	DMX Signal Cable - Universe		DMX Signal Cable - Satellite			
T24-OD-C3-WT	T24-OD-MW60 T24-OD-MW120		T24-OD-SW60 T24-OD-SW120			

See Accessories page for more detail

Example installation for Wireless and DMX control

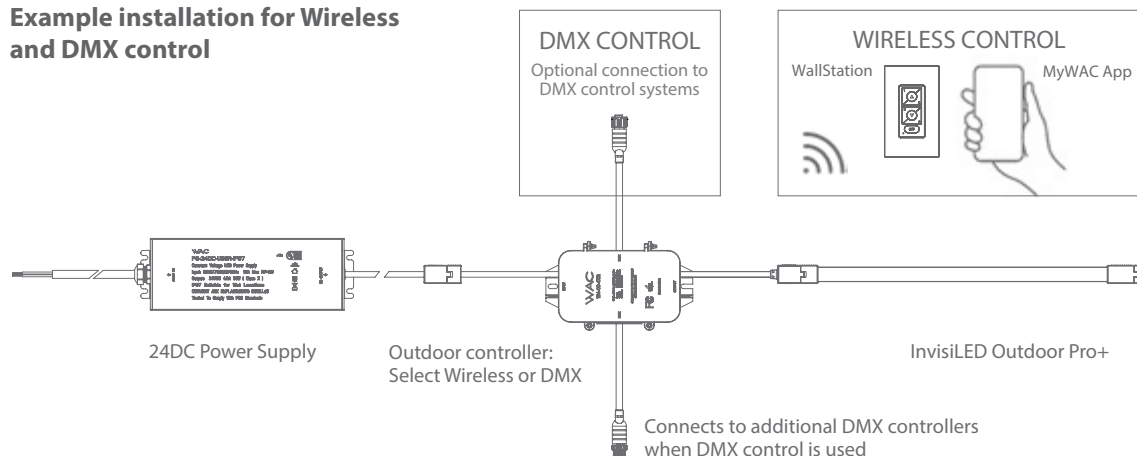

24VDC OUTDOOR RGBWW

RGBWW LANDSCAPE TAPE LIGHTING



- Weatherproof resilience for all conditions
- Advanced IP66 rated protective silicone jacket
- Vivid full color spectrum
- Precisely tunable white light for perfect ambiance
- High-Definition vivid white illumination with superior CRI
- Effortless connectivity: plug and play connectors offer easy integration and hassle-free installation
- Comprehensive smart home system compatibility
- Cuttable every 2 inches and sealable with end caps for custom lengths

Ordering Chart

24VDC		Fixture Finish:	
01	1 foot	CC	White
05	5 feet		
10	10 feet		
15	15 feet		
25	25 feet		

Example: **T24-OD1-01-CC**

Input	Power	Lm/ft	Color Temp	CRI	Rated Life	Cutting Length
24VDC	3.57W/ft * 5.5W/ft **	White	100 lm/ft	R/G/B	90	50,000 hours
		Red	9.7 lm/ft	2700K-5000K		
		Green	34 lm/ft			
		Blue	10.4 lm/ft			

*MyWAC App/Wallstation Control

**DMX Control



Max Run Length/ Control Through Outdoor Wireless DMX Controller - T24-OD-CTR

Total Length of Lead Wire Between Controller to Tape	MyWAC App/Wallstation	DMX
3ft	25ft	15ft
6ft	22ft	14ft
9ft	18ft	12ft
12ft	15ft	10ft
18ft	12ft	8ft
24ft	10ft	6ft
30ft	8ft	5ft
40ft	6ft	4ft

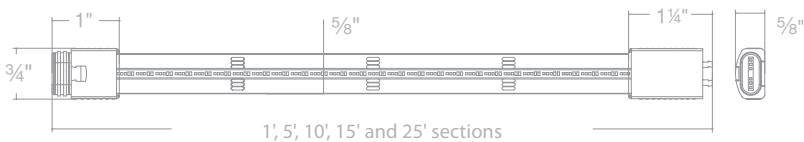

Note: Calculation based on 6' lead wire between power supply and controller



Power Supply

	Model	Input	Output	Dimension	
	PS-24DC-U96R-IP67	120/277VAC	24VDC, 96W	8 3/8" x 2 13/16" x 1 11/16"	Remote Power Supply - Wet Location IP67 Class 2 Output Power Supply. Includes a 6 foot lead wire.
	PS-24DC-U96R-IP45	120/277VAC	24VDC, 96W	8 13/16" x 2 1/16" x 1 3/4"	Remote Power Supply - Damp Location IP45 Class 2 Output Power Supply. Includes a 6 foot lead wire.
	PS-24DC-A96P-OD	120VAC	24VDC, 96W	8 3/8" x 2 13/16" x 1 11/16"	Portable Power Supply - Wet Location IP67 Class 2 Output Power Supply. Includes a 6 foot lead wire.

Controller

	T24-OD-CTR	24VDC, 96W Max from power supply 3ft input cable included	24VDC, 90W Max 3ft output cable included	5" x 3 1/2" x 1 1/2"	Outdoor Wireless DMX Controller Allows outdoor tape to be wirelessly controlled through MyWAC app, WallStation, or DMX. IP65 wet rated *Wi-Fi network is required to operate the system. This controller consumes 6W power Max
	LED-WCT-WT	120-230VAC	N/A	4 5/8" x 2 3/4" x 1 5/8"	WallStation Multi-scene selection/Dimming Control, dedicated Off button/Suitable for standard single NEMA wall box Setup and configuration via MyWAC mobile application

Accessories

Joiner Cable	Y Connector	X Connector	End Cap	5' Clear Channel	Surface Mounting Clip	Edge Mounting Clip
T24-OD-IC6-WT T24-OD-IC12-WT T24-OD-IC72-WT T24-OD-IC120-WT	T24-OD-Y-WT	T24-OD-X-WT	T24-OD-EC-WT	T24-OD-CH5-CL	T24-OD-C1-WT	T24-OD-C2-WT

Underside Mounting Clip

T24-OD-C3-WT

DMX Signal Cable - Universe

T24-OD-MW60
T24-OD-MW120

DMX Signal Cable - Satellite

T24-OD-SW60
T24-OD-SW120

See Accessories page for more detail

Example installation for Wireless and DMX control

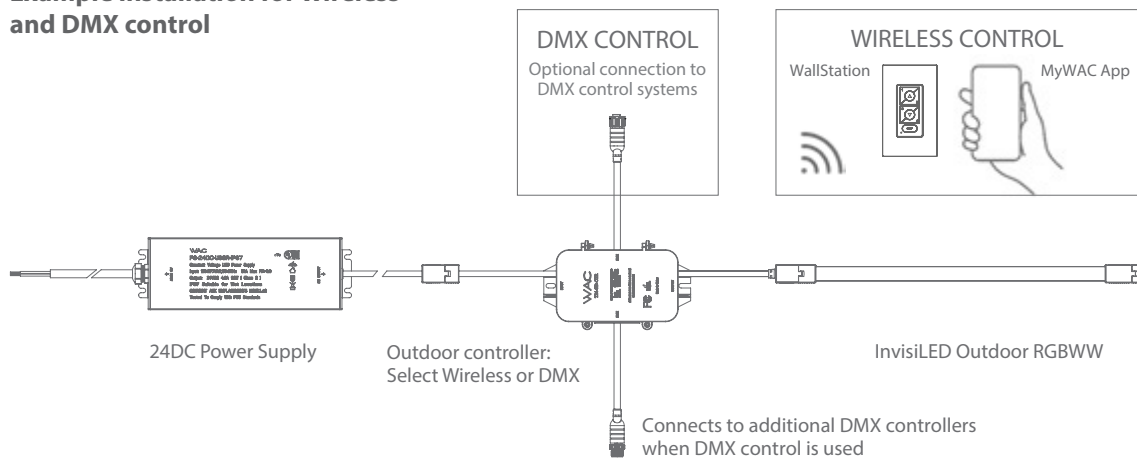



1838 listed

- Translucent lens provides for uniform diffused light output
- 100%-10% dimming - see specification for list of tested dimmers
- Solid die-cast brass or corrosion resistant aluminum alloy
- 6' lead wire and direct burial gel filled wire nuts included

Transformer Required (order separately)
See photometric data on page 128



3011

Ordering Chart

3011-27
3011-30

Fixture Finish Options:

BK Black on Aluminum
BZ Bronze on Aluminum
BBR Bronze on Brass
WT White on Aluminum

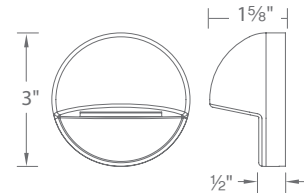

Example: **3011-27WT**

Input	Power	Brightness	Color Temp	CRI	Rated Life
9 - 15VAC	2.8W - 4.6VA	60lm	2700K, 3000K	90	50,000 hours



3021

Ordering Chart

3021-27
3021-30

Fixture Finish Options:

BK Black on Aluminum
BZ Bronze on Aluminum
BBR Bronze on Brass
WT White on Aluminum

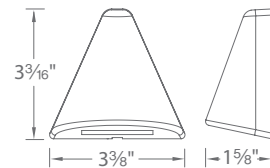

Example: **3021-27BZ**

Input	Power	Brightness	Color Temp	CRI	Rated Life
9 - 15VAC	2.8W - 4.6VA	60lm	2700K, 3000K	90	50,000 hours



3031

Ordering Chart

12V

3031-27
3031-30

Fixture Finish Options:

BK Black on Aluminum
BZ Bronze on Aluminum
BBR Bronze on Brass
WT White on Aluminum

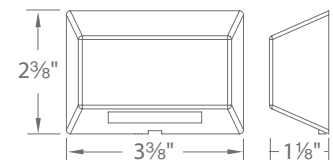

Example: **3031-27BK**

Input	Power	Brightness	Color Temp	CRI	Rated Life
9 - 15VAC	2.8W - 4.6VA	75lm	2700K, 3000K	90	50,000 hours



DECK & PATIO
LANDSCAPE





STEP LIGHTS

Designed with architectural aesthetics and performance in mind, Step Lights offer a sleek profile and fit into a standard junction box. Constructed of marine grade stainless steel suitable for coastal environments.

STEP LIGHTS **LANDSCAPE**



1838 listed (12V)
1598 listed (120V)

- Solid stainless steel construction
- Includes a spring clip for wall or step applications
- 6' lead wire
- Corrosion resistant aluminum alloy, or cast stainless steel construction
- Anti-microbial white paint

SQUARE STEP LIGHTS

Ordering Chart

12V

Fixture Finish Options:

2061-27
2061-30

BS Bronze Stainless Steel
SS Stainless Steel

Example: **2061-30BS**

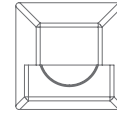

2 3/4"

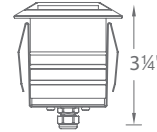

1 7/8"

3 1/4"

Input	Power	Brightness	Color Temp	CRI	Rated Life
9-15VAC	4.1W / 6.6VA	55lm	2700K, 3000K	85	70,000 hours

RECTANGLE STEP LIGHTS

Ordering Chart

12V

Fixture Finish Options:

4011-27
4011-30
4011-AM

BZ Bronze on Aluminum
BK Black on Aluminum
BBR* Bronze on Brass
SS** Cast Stainless Steel
WT White on Aluminum

Example: **4011-30BZ**

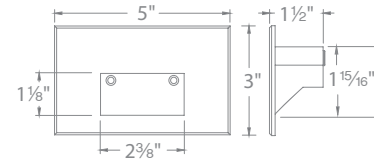

Ordering Chart

12V

Fixture Finish Options:

4021-27
4021-30
4021-AM

BZ Bronze on Aluminum
BK Black on Aluminum
SS** Cast Stainless Steel
WT White on Aluminum

Example: **4021-30BK**

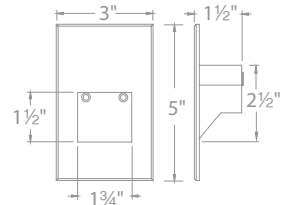

	Input	Power	Brightness	Color Temp	CRI	Rated Life
12V	9-15VAC	2W / 3.1VA	Up to 38 lm	2700K & 3000K & Amber	90	60,000 hours
Transformer Required (order separately)						
120V	110-120VAC	3.5W	Up to 65 lm	3000K	90	54,000 hours

*BBR finish available for 4011 model only

**Cast Stainless Steel finish is only available in 3000K and Amber colors.



STEP LIGHTS
LANDSCAPE

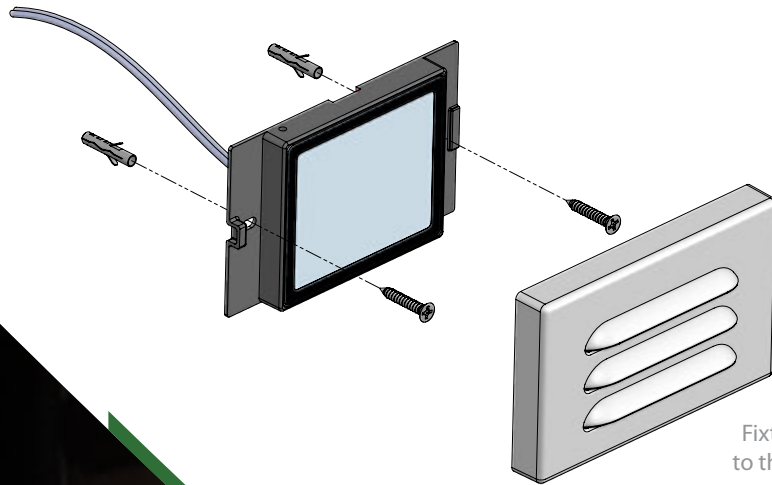

Fixture can be mounted directly to the wall without a junction box



SURFACE MOUNTED STEP LIGHT LANDSCAPE



1838 listed



SURFACE MOUNTED STEP LIGHT **LANDSCAPE** **LOW PROFILE INSTALLATION**

- Slim, low profile design-surface mount installation
- Junction box not required
- Die-cast aluminum or die-cast brass
- Invisible hardware
- 6' lead wire included
- Compatible with WAC® 12V Landscape Transformers (*sold separately*)

Ordering Chart

12V

Fixture Finish Options:

4901-27
4901-30

BZ Bronze on Aluminum
BK Black on Aluminum
BBR Bronze on Brass
WT White on Aluminum

Example: **4901-27BK**



Input	Power	Brightness	Color Temp	CRI	Rated Life
9-15V	8W/12VA	100lm	2700K, 3000K	90	70,000 hours

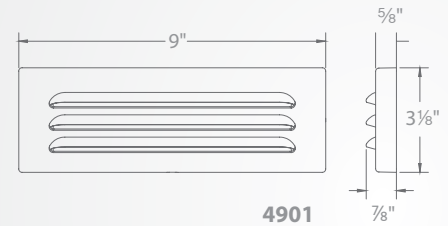

Ordering Chart

12V

Fixture Finish Options:

4501-27
4501-30

BZ Bronze on Aluminum
BK Black on Aluminum
BBR Bronze on Brass
WT White on Aluminum

Example: **4501-30WT**

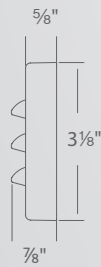
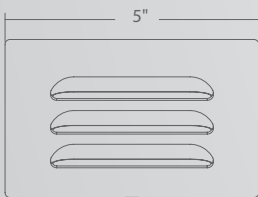

Input	Power	Brightness	Color Temp	CRI	Rated Life
9-15V	4W/6.5VA	55lm	2700K, 3000K	90	70,000 hours

12V & 120V RECTANGULAR STEP & WALL LIGHTS

LANDSCAPE

- Fluid decorative profile with full cut-off illumination
- Die-cast aluminum construction with abrasion-resistant powder-coated finish
- Title 24 Compliant (120V only)

Ordering Chart

12V

4031-27	BK
4031-30	BZ
4031-AM	WT

120V

WL-LED110-C	BN
WL-LED110-AM	BK
	BZ
	WT

Fixture Finish Options:

BN	Brushed Nickel on AL
BK	Black on Aluminum
BZ	Bronze on Aluminum
WT	White on Aluminum

Example: **WL-LED110-C-WT**

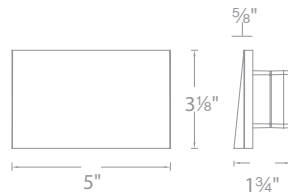

Ordering Chart

12V

4041-27	BK
4041-30	BZ
4041-AM	WT

120V

WL-LED210-C	BN
WL-LED210-AM	BK
	BZ
	WT

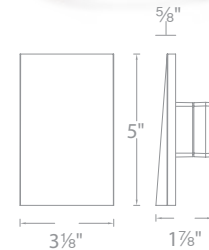

Input	Power	Brightness	Color Temp	CRI	Dimming	Rated Life
12V	2W / 3.1VA	Up to 4 lm	2700K, 3000K & Amber	90	100%-10% MLV	60,000 hours
Transformer Required (order separately)						
120V	3.5W	Up to 4 lm	3000K & Amber	90	100%-10% ELV	50,000 hours

- Geometric design with downward illumination
- Die-cast aluminum construction with abrasion-resistant powder-coated finish
- Title 24 Compliant (120V only)

Ordering Chart

12V

4091-27	BK
4091-30	BZ
4091-AM	WT

120V

WL-LED140-C	BK
WL-LED140-AM	BZ
	WT

Fixture Finish Options:

BK	Black on Aluminum
BZ	Bronze on Aluminum
WT	White on Aluminum

Example: **WL-LED140-C-BK**

IP66 Rated self contained fixture with various face plates. Fits into a switch box or a 2" x 4" junction box with minimum inside dimensions of 3"L x 2"W x 2.5"D.

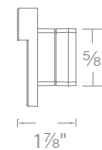
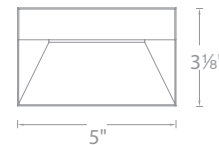

Input	Power	Brightness	Color Temp	CRI	Dimming	Rated Life
12V	2W / 3.1VA	Up to 2 lm	2000K 3000K Amber	90	100%-10% MLV	60,000 hours
Transformer Required (order separately)						
120V	3.5W	Up to 3 lm	2000K 3000K	90	100%-10% ELV	50,000 hours

- Tempered glass diffuses light for even illumination
- Die-cast aluminum construction with abrasion-resistant powder-coated finish, or marine-grade stainless steel option available
- Title 24 Compliant (120V only)

Mounts Vertically or Horizontally

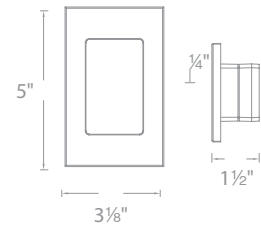
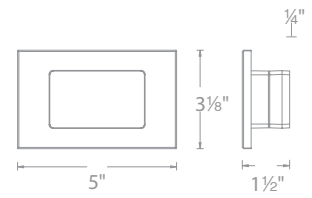

Ordering Chart

12V

4071-27	BK
4071-30	BZ
4071-AM	SS
	WT

Fixture Finish Options:

BK	Black on Aluminum
BZ	Bronze on Aluminum
SS	Stainless Steel
WT	White on Aluminum

120V

WL-LED130-C	BK
WL-LED130-AM	BZ
	SS
	WT

Example: **WL-LED130-C-SS**

Input	Power	Brightness	Color Temp	CRI	Dimming	Rated Life
12V	2W / 3.1VA	Up to 28 lm	2700K, 3000K & Amber	90	100%-10% MLV	60,000 hours
Transformer Required (order separately)						
120V	3.5W	Up to 40 lm	3000K & Amber	90	100%-10% ELV	50,000 hours

- Louvered design shields glare for visual interest
- Die-cast aluminum construction with abrasion-resistant powder-coated finish
- Title 24 Compliant (120V only)

Ordering Chart

12V

4051-27
4051-30
4051-AM

Ordering Chart

12V

4061-27
4061-30
4061-AM

Fixture Finish Options:

BK	Black on Aluminum
BZ	Bronze on Aluminum
WT	White on Aluminum

120V

WL-LED120-C
WL-LED120-AM

120V

WL-LED220-C
WL-LED220-AM

Example: **WL-LED220-C-BZ**

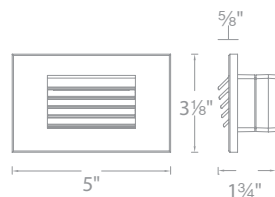
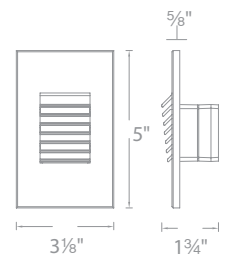

Input	Power	Brightness	Color Temp	CRI	Dimming	Rated Life
12V	2W / 3.1VA	Up to 17 lm	2700K 3000K Amber	90	100%-10% MLV	60,000 hours
Transformer Required (order separately)						
120V	3.5W	Up to 36 lm	3000K Amber	90	100%-10% ELV	50,000 hours

LINE VOLTAGE LED LANDSCAPE OFFERING



ACCENT 120V PATENTED

Integral brightness control, adjustable beam angle



Fixture Finish Options:

- 5012-30BK** Black on Aluminum
- 5012-30BZ** Bronze on Aluminum
- 5012-30BBR** Bronze on Brass

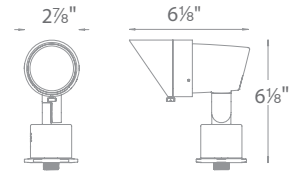

Power	Brightness	Beam Angle	CRI	Color Temp	Rated Life	Listing
3.5W to 14.5W	100lm - 900lm	15° to 60°	85	3000K	45,000 hours	IP-66

See photometric data on page 122

WALL WASH 120V PATENTED

Integral brightness control



Fixture Finish Options:

- 5022-30BK** Black on Aluminum
- 5022-30BZ** Bronze on Aluminum
- 5022-30BBR** Bronze on Brass

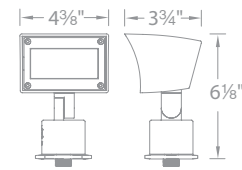

Power	Brightness	Beam Angle	CRI	Color Temp	Rated Life	Listing
3.5W to 14.5W	95lm - 855lm	15° upward (50° by 80°)	85	3000K	45,000 hours	IP-66

See photometric data on page 129

3" INGROUND 120V PATENTED

Integral brightness control, adjustable beam angle



Fixture Finish Options:

- 5032-30BZ** Bronze on Aluminum
- 5032-30BBR** Bronze on Brass

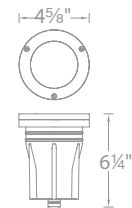

Power	Brightness	Beam Angle	CRI	Color Temp	Rated Life	Listing
3.5W to 11.5W	65lm - 515lm	15° - 60°	85	3000K	45,000 hours	IP-67

See photometric data on page 126

BOLLARDS 120V-277V

SCOOP

See pages 63 - 64



CHAMBER

See pages 65 - 66



TOWER

See pages 69 - 70



ARCHETYPE

See pages 71 - 72





SHINING FROM THE BACKGROUND

Like professional stagehands, these high-performers easily disappear into the backdrop with their diminutive sizes while adaptably making the whole show possible

Featuring product: **5012-30BZ** Accent





ENDURANCE

The Brick Wall Light wall block provides dimmable ambient illumination with a diminutive form. Wall Packs are hermetically sealed, water and dust tight with die-cast aluminum assembly, and capped conduits for motion and photos sensors. The Endurance Flood light fixtures offer sleek style, safety and function.

Endurance® FLOOD LIGHTS

TWO LEVELS OF BRIGHTNESS, SAME COMPACT SIZE



- Breathable waterproof technology and factory-sealed LED light engine ensures fixture can maintain stable atmospheric pressure and prevent condensation
- Die-cast aluminum construction
- Specify 2 lumen packages using the same sized fixture for building facade design integrity
- 120V direct wire—no driver needed
- 1/2" threaded heavy-duty mounting arm
- Photo or motion sensor sold separately



Ordering Chart

120V

Fixture Finish Options:

WP-LED335 **30**
50

aBK *Architectural Black*
aBZ *Architectural Bronze*
aGH *Architectural Graphite*
aWT *Architectural White*

WP-LED354 **35**

Example: **WP-LED354-35-AWT**

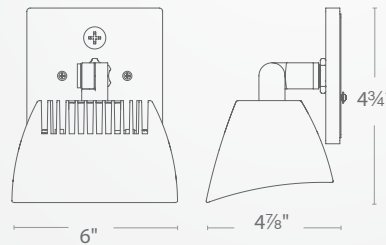

	Model	Input	Power	Brightness	Color Temp	CRI	Dimming	Rated Life
Flood	WP-LED335	120V	35.5W	2450lm 2730lm	3000K 5000K	90	100% - 10% ELV	54,000 hours
Flood Pro	WP-LED354	120V	53W	3445lm	3500K	90	100% - 10% ELV	54,000 hours

MOTION SENSOR (120V)

Available in 4 complementary colors



MS-120-BK *Black*
MS-120-BZ *Bronze*
MS-120-GY *Gray*
MS-120-WT *White*

PHOTOSENSOR (120V)

Available in 4 complementary colors



PC-120-BK *Black*
PC-120-BZ *Bronze*
PC-120-GY *Gray*
PC-120-WT *White*



Ceiling Mounted
360° Horizontal rotation
90° Vertical aiming



Shown with Round Canopy
 Box includes two canopies
 for use with surface mount
 or recessed junction boxes



Shown in Architectural White
 Two different power options
 in one compact size

OPEN ILLUMINATION BRICK LIGHT
WL-5105 Opal

Input	Power	Brightness	Color Temp	CRI	Dimming	Rated Life
120V	5.5W	Up to 45 lm	3000K	90	100% - 10% ELV	80,000 hours

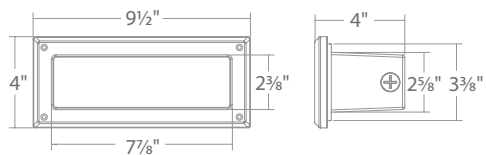

Ordering Chart

120V

Fixture Finish Options:

WL-5105-30

- aBK** Architectural Black
- aBZ** Architectural Bronze
- aGH** Architectural Graphite
- aWT** Architectural White

Example: **WL-5105-30-AWT**

Endurance® BRICK LIGHTS



LOW GLARE BRICK LIGHT
WL-5205 Louver

- Option to easily retrofit Hadco or Kichler incandescent brick lights using the existing housings
- Factory-sealed LED light engine
- Die-cast aluminum construction
- 120V direct wire - no driver needed



Ordering Chart

120V

WL-5205-30

Fixture Finish Options:

- aBK** Architectural Black
- aBZ** Architectural Bronze
- aGH** Architectural Graphite
- aWT** Architectural White

Example: **WL-5205-30-ABK**

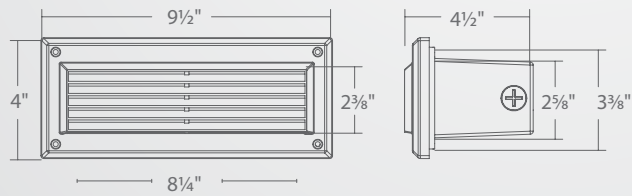

Input	Power	Brightness	Color Temp	CRI	Dimming	Rated Life
120V	5.5W	Up to 110 lm	3000K	90	100% - 10% ELV	80,000 hours

Endurance® LED FLOOD LIGHTS

SINGLE SPOT



- Factory-sealed LED light engine
- Die-cast aluminum construction
- 120V direct wire - no driver needed
- Photo/Motion sensor sold separately



Ordering Chart

120V

WP-LED415-30
WP-LED415-50

Fixture Finish Options:

aBK	Architectural Black
aBZ	Architectural Bronze
aGH	Architectural Graphite
aWT	Architectural White

Example: **WP-LED415-30-AWT**

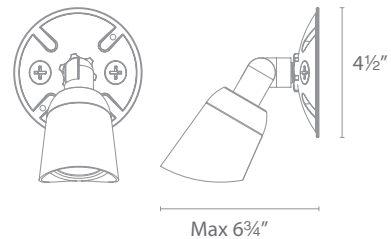

Max 6 3/4"

Input	Power	Brightness	Color Temp	CRI	Dimming	Rated Life
120V	15W	965lm 1030lm	3000K 5000K	90	100% - 10% ELV	54,000 hours

PHOTOSENSOR (120V)

Available in 4 complementary colors



PC-120-BK	Black
PC-120-BZ	Bronze
PC-120-GY	Gray
PC-120-WT	White

MOTION SENSOR (120V)

Available in 4 complementary colors



MS-120-BK	Black
MS-120-BZ	Bronze
MS-120-GY	Gray
MS-120-WT	White



Endurance® FLOOD LIGHTS DOUBLE SPOT

- Factory-sealed LED light engine
- Die-cast aluminum construction
- 120V direct wire - no driver needed
- Photo/Motion sensor sold separately



Ordering Chart

120V

WP-LED430-30
WP-LED430-50

Fixture Finish Options:

aBK Architectural Black
aBZ Architectural Bronze
aGH Architectural Graphite
aWT Architectural White

Example: **WP-LED430-30-ABZ**

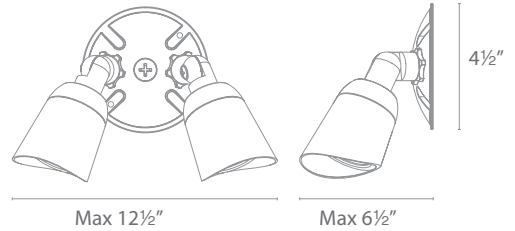

Input	Power	Brightness	Color Temp	CRI	Dimming	Rated Life
120V	30W	965lm x 2 1030lm x 2	3000K 5000K	85	100% - 10% ELV	50,000 hours

PHOTOSENSOR (120V)

Available in 4 complementary colors



PC-120-BK Black
PC-120-BZ Bronze
PC-120-GY Gray
PC-120-WT White

MOTION SENSOR (120V)

Available in 4 complementary colors



MS-120-BK Black
MS-120-BZ Bronze
MS-120-GY Gray
MS-120-WT White

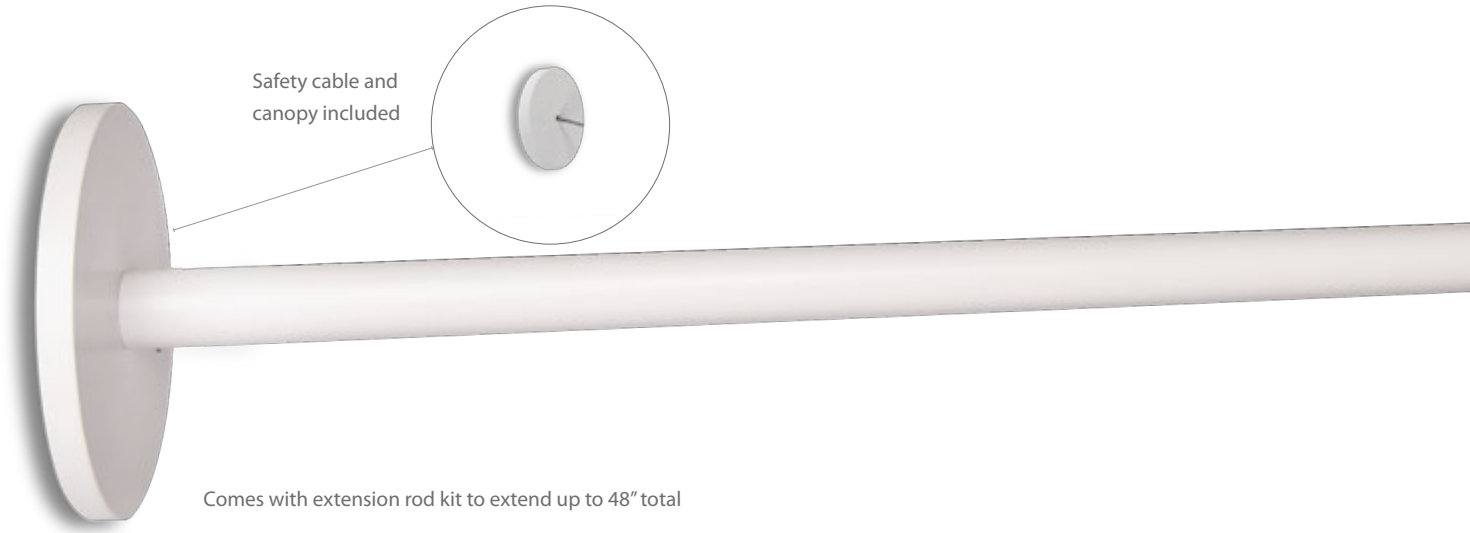

Comes with extension rod kit to extend up to 48" total

**SINGLE
WP-LED514**

Ordering Chart

120V	Fixture Finish Options:
WP-LED514-30	aBK Architectural Black
WP-LED514-40	aBZ Architectural Bronze
	aGH Architectural Graphite
	aWT Architectural White

Example: **WP-LED514-30-ABK**

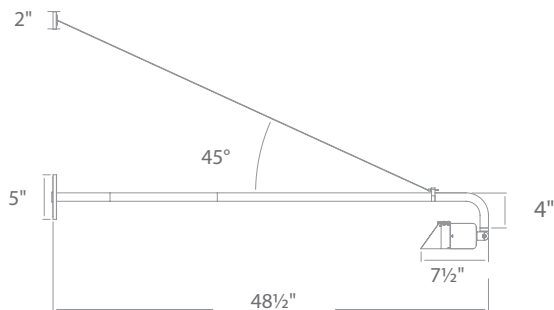

Input	Power	Brightness	Color Temp	CRI	Dimming	Rated Life
120V	15W	Up to 1140 lm	3000K, 4000K	85	100% - 10% ELV	50,000 hours

Endurance® WALL-MOUNTED SPOTLIGHT

DESIGNED FOR SIGN OR WALL-MOUNTED LIGHTING IN ANY DIRECTION

Safety cable recommended for extensions over 36"

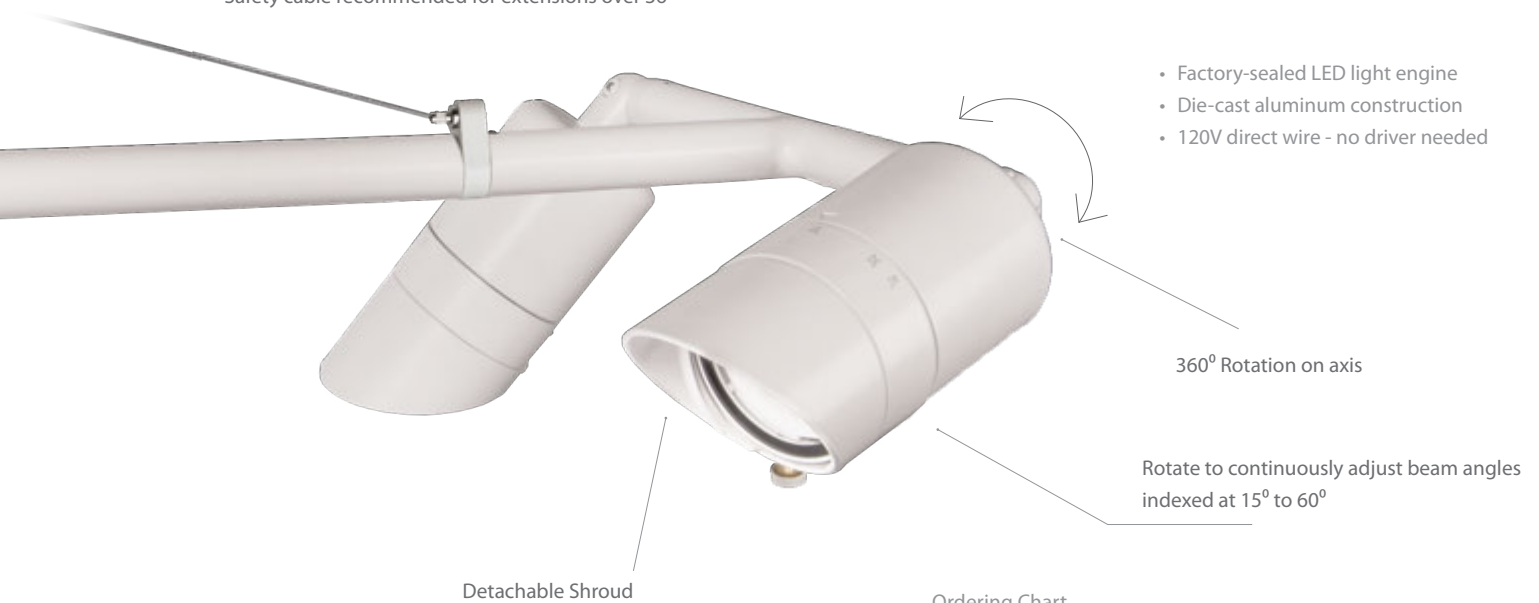

- Factory-sealed LED light engine
- Die-cast aluminum construction
- 120V direct wire - no driver needed

360° Rotation on axis

Rotate to continuously adjust beam angles indexed at 15° to 60°

Detachable Shroud

Ordering Chart

120V	Fixture Finish Options:
WP-LED529-30	aBK Architectural Black
WP-LED529-40	aBZ Architectural Bronze
	aGH Architectural Graphite
	aWT Architectural White

DOUBLE WP-LED529

Example: **WP-LED529-30-AWT**

Input	Power	Brightness	Color Temp	CRI	Dimming	Rated Life
120V	30W	Up to 1140 lm x2	3000K, 4000K	85	100% - 10% ELV	50,000 hours

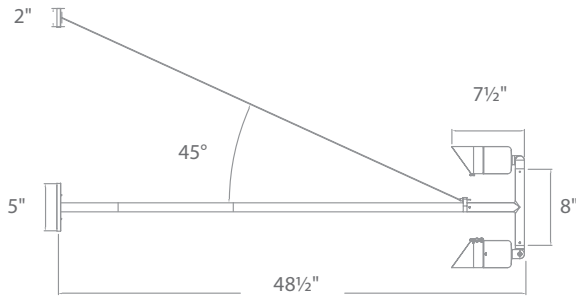

PHOTOMETRICS

Beam Setting	Power 15W Per Head		
	Distance	Foot Candles	Beam Diameter
15°	2ft	1035.8fc	0.5ft
	3ft	460.3fc	1.0ft
	4ft	258.9fc	1.0ft
25°	2ft	600.0fc	1.0ft
	3ft	266.7fc	1.5ft
	4ft	150.0fc	2.0ft
40°	2ft	378.0fc	1.5ft
	3ft	168.0fc	2.0ft
	4ft	94.5fc	3.0ft
60°	2ft	218.8fc	2.5ft
	3ft	92.7fc	3.5ft
	4ft	54.7fc	4.5ft





- Factory-sealed LED light engine
- Die-cast aluminum construction
- 20° forward throw illumination
- Built-in level for easy adjustment
- Photo/Motion sensor sold separately

Tempered Prismatic Glass
Reduces glare while optimizing light distribution

Ordering Chart

120V - 277V

Fixture Finish Options:

WP-LED119-30	aBZ	Architectural Bronze
WP-LED127-30	aGH	Architectural Graphite
WP-LED135-30	aWT	Architectural White

Example: **WP-LED119-30-AGH**

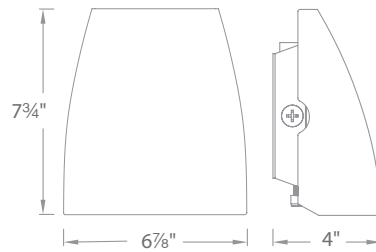

Input	Power	Brightness	Color Temp	CRI	Dimming	Rated Life
120V-277V	19W/27W/35W	1390/2075/2750 lm	3000K	85	100% - 10% ELV or 0-10V	100,000 hours

MOTION SENSOR (120V)

Available in 3 complementary colors



- MS-120-BZ** Bronze
- MS-120-GY** Gray
- MS-120-WT** White

PHOTOSENSOR (120V)

Available in 3 complementary colors



- PC-120-BZ** Bronze
- PC-120-GY** Gray
- PC-120-WT** White



- Factory-sealed LED light engine
- Die-cast aluminum construction
- 20° forward throw illumination
- Built-in level for easy adjustment
- Photo/Motion sensor sold separately



Mounts in any orientation for direct and indirect illumination



Includes box sleeve. For use with surface mount junction boxes

Ordering Chart

120V - 277V

Fixture Finish Options:

WP-LED219-30
WP-LED227-30

aBZ Architectural Bronze
aGH Architectural Graphite
aWT Architectural White

Example: **WP-LED219-30-ABZ**

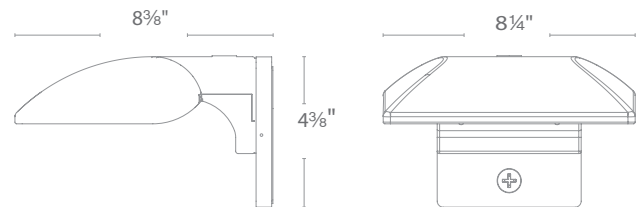

Input	Power	Brightness	Color Temp	CRI	Dimming	Rated Life
120V-277V	19W/27W	1435 lm/2095 lm	3000K	85	100% - 10% ELV or 0-10V	100,000 hours

MOTION SENSOR (120V)

Available in 3 complementary colors



MS-120-BZ Bronze
MS-120-GY Gray
MS-120-WT White

PHOTOSENSOR (120V)

Available in 3 complementary colors



PC-120-BZ Bronze
PC-120-GY Gray
PC-120-WT White





DECORATIVE

Versatile, sleek and compact, Tube features cleanly finished aluminum construction with no visible hardware. It deploys distinctive, focused up-and-down accent and wall wash lighting with built-in reflectors for superior optics. Available with various light distributions and beam angles and includes a replaceable LED module.

RUBIX DECORATIVE CEILING MOUNTS

- Ceiling mount
- Die-cast aluminum construction

CEILING MOUNT



Ordering Chart

120V - 277V

Fixture Finish Options:

FM-W2505

AL	Brushed Aluminum
BK	Black
BZ	Bronze
GH	Graphite
WT	White

Example: **FM-W2505-WT**

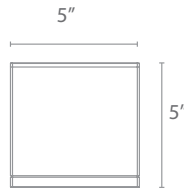

Input	Power	Brightness	Beam Angle	Dimming	Color Temp	CRI	Rated Life
120-277V	16W	750lm	86°	100% - 10% ELV or 0-10V	3000K	90	70,000 hours

CEILING MOUNT



Ordering Chart

120V - 277V

Fixture Finish Options:

FM-W2510

AL	Brushed Aluminum
BK	Black
BZ	Bronze
GH	Graphite
WT	White

Example: **FM-W2510-BZ**

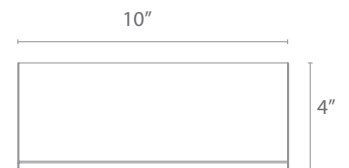

Input	Power	Brightness	Beam Angle	Dimming	Color Temp	CRI	Rated Life
120-277V	30W	1875lm	95°	100% - 10% ELV or 0-10V	3000K	90	70,000 hours

RUBIX & SCOOP DECORATIVE WALL MOUNTS

Fixture Finish Options:

AL	Brushed Aluminum
BK	Black
BZ	Bronze
GH	Graphite
WT	White

- Mounts up or down
- Die-cast aluminum construction

Input	Dimming	Color Temp	CRI	Rated Life
120-277V	100% - 10% ELV or 0-10V	3000K	90	70,000 hours

WALL MOUNT



SINGLE LIGHT WS-W2509



Ordering Chart
120V - 277V

WS-W2509

Example: **FM-W2509-WT**

Beam Angle	Power	Brightness
86°	16W	805lm

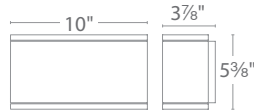

WALL MOUNT



UP & DOWN LIGHT WS-W2510



Ordering Chart
120V - 277V

WS-W2510

Example: **FM-W2509-GH**

Beam Angle	Power	Brightness
86°	30W	805lm

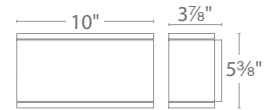

WALL MOUNT



Ordering Chart
120V - 277V

WS-W2504 WS-W2505

Example: **WS-W2504-BZ**

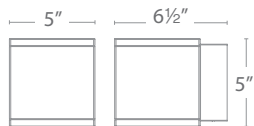

Model	Beam Angle	Power	Brightness
WS-W2504 - SINGLE	86°	16W	750lm
WS-W2505 - UP & DOWN	86°	30W	1400lm

Input	Dimming	Color Temp	CRI	Rated Life
120-277V	100% - 10% ELV or 0-10V	3000K	90	70,000 hours

SCOOP WALL MOUNT



Ordering Chart
120V - 277V

WS-W20506

Example: **WS-W20506-BK**

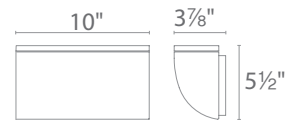

Beam Angle	Power	Brightness
86°	16W	805lm

TUBE DECORATIVE PENDANT & CEILING MOUNTS

PENDANT



- Die-cast aluminum construction
- Hang straight swivel
- Three 12" and one 6" down rods included

Ordering Chart

120V - 277V

Fixture Finish Options:

PD-W2605

AL	Brushed Aluminum
BK	Black
BZ	Bronze
GH	Graphite
WT	White

Example: **PD-W2605-BK**

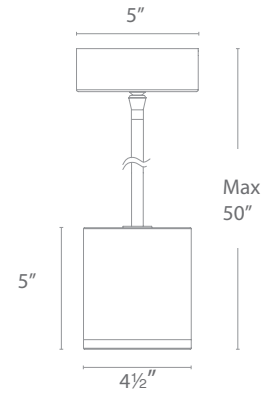

Input	Power	Brightness	Beam Angle	Dimming	Color Temp	CRI	Rated Life
120-277V	16W	800lm	33°	100% - 10% ELV or 0-10V	3000K	90	70,000 hours

CEILING MOUNT



- Die-cast aluminum construction

Ordering Chart

120V - 277V

Fixture Finish Options:

FM-W2605

AL	Brushed Aluminum
BK	Black
BZ	Bronze
GH	Graphite
WT	White

Example: **FM-W2605-WT**

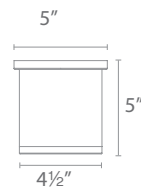

Beam Angle	Power	Brightness
35°	16W	800lm



Ordering Chart

120V-277V

Fixture Finish Options:

FM-W2612

AL	Brushed Aluminum
BK	Black
BZ	Bronze
GH	Graphite
WT	White

Example: **FM-W2612-GH**

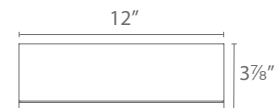

Beam Angle	Power	Brightness
91°	30W	1740lm

Input	Power	Brightness	Beam Angle	Dimming	Color Temp	CRI	Rated Life
120-277V	16W	800lm	33°	100% - 10% ELV or 0-10V	3000K	90	70,000 hours

TUBE DECORATIVE WALL MOUNTS

4" SINGLE LIGHT WALL MOUNT

- Mounts up or down
- Die-cast aluminum construction



Ordering Chart

120V - 277V

WS-W2605

Fixture Finish Options:

AL	Brushed Aluminum
BK	Black
BZ	Bronze
GH	Graphite
WT	White

Example: **WS-W2605-GH**

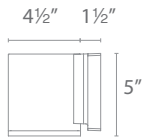

Beam Angle	Power	Brightness
33°	16W	800lm



Input	Dimming	Color Temp	CRI	Rated Life
120-277V	100% - 10% ELV or 0-10V	3000K	90	70,000 hours

4" DOUBLE LIGHT WALL MOUNT

- Die-cast aluminum construction



Ordering Chart

120V - 277V

WS-W2604

Fixture Finish Options:

AL	Brushed Aluminum
BK	Black
BZ	Bronze
GH	Graphite
WT	White

Example: **WS-W2604-BZ**

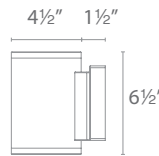

Beam Angle	Power	Brightness
33°	30W	1750lm



SINGLE LIGHT WALL MOUNT

- Mounts up or down
- Die-cast aluminum construction



Ordering Chart

120V - 277V

WS-W2609

Fixture Finish Options:

AL	Brushed Aluminum
BK	Black
BZ	Bronze
GH	Graphite
WT	White

Example: **WS-W2609-BK**



Beam Angle	Power	Brightness
70°	16W	825lm



Input	Dimming	Color Temp	CRI	Rated Life
120-277V	100% - 10% ELV or 0-10V	3000K	90	70,000 hours

DOUBLE LIGHT WALL MOUNT

- Die-cast aluminum construction



Ordering Chart

120V - 277V

WS-W2610

Fixture Finish Options:

AL	Brushed Aluminum
BK	Black
BZ	Bronze
GH	Graphite
WT	White

Example: **WS-W2610-WT**



Beam Angle	Power	Brightness
70°	30W	1525lm



TRANSFORMER **LANDSCAPE**

From our fully adjustable integrated LED accent light to our submersible in-grounds, every product is engineered to work well together as a fully integrated solution. We have everything you need whether you're lighting a small jewel of a garden or a sublime outdoor oasis, all connected to the same transformer.







- 12V to 15V taps
- Knockouts for power and photo sensor connections
- 3-prong outlet for timer
- Outdoor Rated stainless steel transformer contains an outdoor Rated 3-prong plug for power

Model	
9075-TRN-SS	75W Max Dimensions: 13.97" L x 5.35"W x 5.63"H
9150-TRN-SS	150W Max Dimensions: 18.90" L x 6.69"W x 6.30"H
9300-TRN-SS	300W Max Dimensions: 18.90" L x 6.69"W x 6.30"H
9600-TRN-SS	600W Max (2 x 300W outputs) Dimensions: 14.49" L x 10.08"W x 5.94"H





ACCESSORIES **LANDSCAPE**



Accessories LED LANDSCAPE

External Low Voltage MLV Dimmer		9000-MLV-BK	Black on Aluminum	Max Load: Up to 150W at 12V AC No Minimum load Capacity: 13A Input Voltage 12-15VAC
Mechanical Timer		9000-MTI-WT	White	Connect within the transformer
Photosensor		9000-PCH-GY	1000VA Max	Attached directly to the transformer
Photosensor - Remote		9000-PCR-GY	1000VA Max	If transformer is located in a shady spot, this photosensor has a 10 foot cord and a stainless steel bracket to secure in a sunny area
Direct Burial Water proof Wire Nuts		9020-WNT-BK		Silicone filled wire nut with gasket (Pack of 20pcs)
12V Direct Burial Outdoor Cable		9100-12G-BK 9250-12G-BK 9500-12G-BK	100 feet 12 gauge 250 feet 12 gauge 500 feet 12 gauge	





Accessories 3" INGROUND

Non-slip lens		5030-NSLEN-CL	Clear/patterned	Slip resistant lens
Rock Guard		5030-GRD-BZ 5030-GRD-BBR	Bronze on Aluminum Bronze on Brass	Protects the fixture surface
Concrete Pour Kit		5030-PIP-PVC	Shown with temporary dense foam cap	For installation in concrete; five 1/2" NPT threaded holes, PC

Accessories GRAND INGROUND















Rock Guard		5830-GRD-BZ 5830-GRD-BBR	Bronze on Aluminum Bronze on Brass	Protects the fixture surface
Concrete Pour Kit		5830-PIP-PVC	Shown with temporary dense foam cap	For installation in concrete; five 1/2" NPT threaded holes, PC

Accessories RECESSED + INGROUND





		2000-CON-PVC 2" Concrete Pour Kit	For installation in concrete. 18" PVC pipe included. installs onto a 4" outdoor rated junction box.
		1000-CON-PVC 1" Concrete Pour Kit	For installation in concrete. 18" PVC pipe included. Installs onto a 4" outdoor rated junction box.

ACCESSORIES LANDSCAPE

Accessories MOUNTING & GLARE CONTROL

5" Long Shroud For 5211/5212 Grand Accent		5211-LSHR-BK 5211-LSHR-BZ 5211-LSHR-BBR	Reduce glare; ideal for downlighting application
6" Long Shroud For 5011/5012 Accent		5010-LSHR-BZ 5010-LSHR-BBR 5010-LSHR-BK	Reduce glare; ideal for downlighting application
5" Long Shroud For 5111 Mini Accent		5111-LSHR-BZ 5111-LSHR-BBR 5111-LSHR-BK	Reduce glare; ideal for downlighting application
Grand Accent Snoot		5211-SNOOT-BK 5211-SNOOT-BZ 5211-SNOOT-BBR	Reduce glare; ideal for downlighting application
Accent Snoot		5010-SNOOT-BK 5010-SNOOT-BZ 5010-SNOOT-BBR	Reduce glare; ideal for downlighting application
Mini Accent Snoot		5111-SNOOT-BK 5111-SNOOT-BZ 5111-SNOOT-BBR	Reduce glare; ideal for downlighting application
9" Mounting Stake		9000-ST9-BZ	Durable PC stake
14" Mounting Stake		9000-ST14-BZ	Durable PC stake
Surface Mount Flange/Stake		5000-SCP-BZ 5000-SCP-BBR 5000-SCP-BK	Includes three 7 inch threaded stainless steel stabilizing pins for ground mounting or surface mounts with four screws or over a junction box
Guardian Mount		9000-SP9-BZ	Heavy duty stainless steel spike to position fixture
Gutter Mount Bracket		5000-GM-BK 5000-GM-BZ 5000-GM-WT	Stainless steel universal mounting bracket for gutter mounting fixture
Tree Mount Junction Box		5000-TCP-BK 5000-TCP-BZ	Aluminum box with stainless steel mounting screws; two 1/2" NPT threaded holes, UL 120V listed
		5000-TCL-BK 5000-TCL-BZ	Large aluminum box with stainless steel mounting screws; two 1/2" NPT threaded holes, UL 120V listed
Large Tree Mount Canopy Strap		5000-TST-BK	Ratcheting device with strap to be used with Large Tree Mount Junction Box (5000-TCL)
		5000-STB-BK	Tree mount bracket only
Rod L-Coupler		5000-LCO-BK 5000-LCO-BZ	

Accessories OPTIC

Grand Accent Optics		LENS-25-AMB LENS-25-GRN LENS-25-RED	Amber Green Red	LENS-25-BLU LENS-25-FR LENS-25-SPR	Blue Frosted Spread	5211-HCL LENS-25-BEL	Honeycomb Louver Elongating Beam
Accent Optics		LENS-20-AMB LENS-20-GRN LENS-20-RED	Amber Green Red	LENS-20-BLU LENS-20-FR LENS-20-SPR	Blue Frosted Spread	5011-HCL LENS-20-BEL	Honeycomb Louver Elongating Beam
Mini Accent Optics		LENS-16-AMB LENS-16-GRN LENS-16-RED	Amber Green Red	LENS-16-BLU LENS-16-FR LENS-16-SPR	Blue Frosted Spread	5111-HCL LENS-16-BEL	Honeycomb Louver Elongating Beam
Mini Wall Wash Optics		LENS-2X3-AMB LENS-2X3-GRN LENS-2X3-RED	Amber Green Red	LENS-2X3-BLU LENS-2X3-FR LENS-2X3-SPR	Blue Frosted Spread	LENS-2X3-BEL	Elongating Beam
Wall Wash Optics		LENS-2X4-AMB LENS-2X4-GRN LENS-2X4-RED	Amber Green Red	LENS-2X4-BLU LENS-2X4-FR LENS-2X4-SPR	Blue Frosted Spread		
NEMA Wall Wash- Optics		LENS-3X5-AMB LENS-3X5-GRN LENS-3X5-RED	Amber Green Red	LENS-3X5-BLU LENS-3X5-FR LENS-3X5-SPR	Blue Frosted Spread	LENS-3X5-BEL	Elongating Beam

ACCESSORIES LANDSCAPE

Accessories LANDSCAPE TAPE LIGHTING

	InvisiLED® Outdoor Joiner Cable Extends power supply lead wire	T24-WE-IC-002-BK 2 in T24-WE-IC-006-BK 6 in T24-WE-IC-012-BK 1 ft T24-WE-IC-036-BK 3 ft T24-WE-IC-072-BK 6 ft T24-WE-IC-144-BK 12 ft T24-WE-IC-240-BK 20ft	Black		InvisiLED® Outdoor Surface Mounting Clip	LED-TO24-C1	Black (10 pieces)
	InvisiLED® Outdoor Lead Wire Connects to Indoor Power Supply	T24-WE-BO12-BK 1 ft T24-WE-BO72-BK 6 ft	Black		InvisiLED® Outdoor Edge Mounting Clip	LED-TO24-C2	Black (10 pieces)
	InvisiLED® Outdoor Power Connector Kit with Wire Jacket and Silicone Sealant Allows power to Wet Rated tape	T24-WE-EX2-006-BK 6 in	Black		InvisiLED® Outdoor Underside Mounting Clip	T24-WE-C3	Black (10 pieces)
	InvisiLED® Outdoor Tape to Tape Y Connector Splits power to the two tape sections	T24-WE-Y-BK	Black		InvisiLED® Outdoor Surface Mount Clear Channel	T24-WE-CH5	5 ft Clear
	Wet Rated Tape End Cap with Silicone Sealant. 24VDC Wet Rated (10 pieces)	T24-WE-EC	Clear		Silicone Sealant Tape Sealant (45 grams)	T24-WE-SI-45	White
	5' Clear Channel	T24-OD-CH5-CL	5 ft	Includes mounting hardware	Clear		
	Invisible Clip	T24-OD-C3-WT		Spring clip secures beneath tape (10pcs/Pack)	White		
	Surface Mounting Clip	T24-OD-C1-WT		For installation on non-flat surfaces where there is no edge contact (10pcs/pack)	White		
	Edge Mounting Clip	T24-OD-C2-WT		For installation on non-flat surfaces, allows for contact on one edge (10 pcs/pack)	White		
	End Cap	T24-OD-EC-WT		Seal cut end with silicone after adding end cap	White		
	Joiner Cable	T24-OD-IC6-WT 6 in T24-OD-IC12-WT 1 ft T24-OD-IC72-WT 6 ft T24-OD-IC120-WT 10 ft		Connects tape, power sections	White		
	4 Way "X" Connector	T24-OD-X-WT		Connects tape sections	White		
	3 Way "Y" Connector	T24-OD-Y-WT		Connects tape sections	White		
	Lead Wire w/ 5A fuse	8002-06WT 6 ft 8002-10WT 10 ft		Lead wire to connect 12V Landscape tape with Landscape Magnetic Transformer	White		
	InvisiLED® Outdoor Joiner Cable	T24-WE-EX-CTR		Joiner cable between wireless controller to InvisiLED® Outdoor Tape	White		
	DMX Signal Cable - Universe	T24-OD-MW60 5 ft T24-OD-MW120 10 ft		DMX to Universe controller	Black		
	DMX Signal Cable - Satellite	T24-OD-SW60 5 ft T24-OD-SW120 10 ft		Master to Satellite controller or Satellite to Satellite	Black		

WAC Patented Products Solve Everyday Challenges

Adjustable Beam Wall Wash

FLEXIBILITY/OPTIONS

Select color temperature option: 2700K or 3000K
Marine-grade Brass or Corrosion Resistant Aluminum Bronze or Black finishes.
12V or 120V
Color lens & optical lens option
Tree mount, wall mount option
Suitable for use as a Wall Wash Light

BRIGHTNESS

Fixture lumen output range of 200lm to 1500lm (in wattage, translates to a range of 3W to 25W of LED power) can be accomplished with a screwdriver for brightness adjustment.

BEAM ANGLE

Architectural beam distributions from 3x4 to 4x5 to 5x6 proportions and everything in between. Rotatable fixture head for vertical distribution. Always a uniform wide beam wash of light.
NEMA 4X3: 60 degrees by 35 degrees
NEMA 5X4: 90 degrees by 60 degrees
NEMA 6X5: 120 degrees by 90 degrees

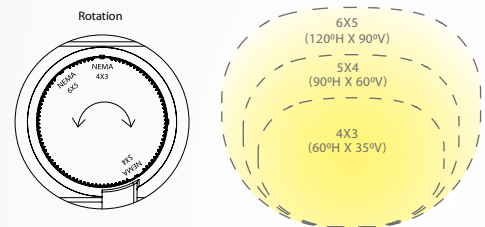

Hardscape Quick Release

BRIGHTNESS

Fixture lumen output range of 10lm to 350lm (in wattage, translates to a range of 0.5W to 8.5W of LED power) can be accomplished with a screwdriver for brightness adjustment.

QUICK RELEASE SERVICEABILITY

Our new patented invention allows for a watertight male/female connection at the fixture for ease of replacement after it is installed.

FLEXIBILITY/OPTIONS

Marine-grade Brass or Corrosion Resistant Aluminum Bronze, Graphite, or Sand finishes.
Select color temperature option : 2700K or 3000K
Removable stainless steel capstone bracket and rotating mounting clips included



Durability. Flexibility. Guaranteed.

Every WAC® lighting fixture in our patented line of technology landscape products is thoroughly tested in our nationally recognized NVLAP, UL, and ETL certified laboratories for safety, durability, and robust long term performance, even in the most rugged environments.

LED Life Expectancy

Rated life of LED lights is based on IES (Illuminating Engineering Society) L70 standard accelerated lifetime testing for how long they will operate until only 70% of the original light output remains.

 Listed to UL 1838 standard (12V) | 1598 standard (120V)

GRAND ACCENT 12V PHOTOMETRICS

At 15° Setting



POWER	15W		22W		26W		30W		33W	
DISTANCE	FOOT CANDLES	BEAM WIDTH	FOOT CANDLES	BEAM WIDTH	FOOT CANDLES	BEAM WIDTH	FOOT CANDLES	BEAM WIDTH	FOOT CANDLES	BEAM WIDTH
4ft	260.4fc	1.1ft	418.4fc	1.1ft	465.4fc	1.1ft	521.4fc	1.1ft	549.3fc	1.1ft
8ft	65.1fc	2.1ft	104.6fc	2.1ft	116.4fc	2.1ft	130.4fc	2.1ft	137.3fc	2.1ft
12ft	28.9fc	3.2ft	46.5fc	3.2ft	51.7fc	3.2ft	57.9fc	3.2ft	61.0fc	3.2ft
16ft	16.3fc	4.2ft	26.2fc	4.2ft	29.1fc	4.2ft	32.6fc	4.2ft	34.3fc	4.2ft
24ft	7.2fc	6.3ft	11.6fc	6.3ft	12.9fc	6.3ft	14.5fc	6.3ft	15.3fc	6.3ft
32ft	4.1fc	8.4ft	6.5fc	8.4ft	7.3fc	8.4ft	8.1fc	8.4ft	8.6fc	8.4ft
40ft	2.6fc	10.5ft	4.2fc	10.5ft	4.7fc	10.5ft	5.2fc	10.5ft	5.5fc	10.5ft
48ft	1.8fc	12.6ft	2.9fc	12.6ft	3.2fc	12.6ft	3.6fc	12.6ft	3.8fc	12.6ft
60ft	1.2fc	15.8ft	1.9fc	15.8ft	2.1fc	15.8ft	2.3fc	15.8ft	2.4fc	15.8ft

At 25° Setting



POWER	15W		22W		26W		30W		33W	
DISTANCE	FOOT CANDLES	BEAM WIDTH	FOOT CANDLES	BEAM WIDTH	FOOT CANDLES	BEAM WIDTH	FOOT CANDLES	BEAM WIDTH	FOOT CANDLES	BEAM WIDTH
4ft	198.0fc	1.8ft	323.3fc	1.8ft	362.6fc	1.8ft	399.3fc	1.8ft	418.4fc	1.8ft
8ft	49.5fc	3.5ft	80.8fc	3.5ft	90.7fc	3.5ft	99.8fc	3.5ft	104.6fc	3.5ft
12ft	22.0fc	5.3ft	35.9fc	5.3ft	40.3fc	5.3ft	44.4fc	5.3ft	46.5fc	5.3ft
16ft	12.4fc	7.1ft	20.2fc	7.1ft	22.7fc	7.1ft	25.0fc	7.1ft	26.2fc	7.1ft
24ft	5.5fc	10.6ft	9.0fc	10.6ft	10.1fc	10.6ft	11.1fc	10.6ft	11.6fc	10.6ft
32ft	3.1fc	14.2ft	5.1fc	14.2ft	5.7fc	14.2ft	6.2fc	14.2ft	6.5fc	14.2ft
40ft	2.0fc	17.7ft	3.2fc	17.7ft	3.6fc	17.7ft	4.0fc	17.7ft	4.2fc	17.7ft
48ft	1.4fc	21.3ft	2.2fc	21.3ft	2.5fc	21.3ft	2.8fc	21.3ft	2.9fc	21.3ft
60ft	0.9fc	26.6ft	1.4fc	26.6ft	1.6fc	26.6ft	1.8fc	26.6ft	1.9fc	26.6ft

At 40° Setting



POWER	15W		22W		26W		30W		33W	
DISTANCE	FOOT CANDLES	BEAM WIDTH	FOOT CANDLES	BEAM WIDTH	FOOT CANDLES	BEAM WIDTH	FOOT CANDLES	BEAM WIDTH	FOOT CANDLES	BEAM WIDTH
4ft	107.4fc	2.9ft	167.4fc	2.9ft	191.5fc	2.9ft	210.8fc	2.9ft	223.2fc	2.9ft
8ft	26.8fc	5.8ft	41.9fc	5.8ft	47.9fc	5.8ft	52.7fc	5.8ft	55.8fc	5.8ft
12ft	11.9fc	8.7ft	18.6fc	8.7ft	21.3fc	8.7ft	23.4fc	8.7ft	24.8fc	8.7ft
16ft	6.7fc	11.6ft	10.5fc	11.6ft	12.0fc	11.6ft	13.2fc	11.6ft	13.9fc	11.6ft
24ft	3.0fc	17.5ft	4.7fc	17.5ft	5.3fc	17.5ft	5.9fc	17.5ft	6.2fc	17.5ft
32ft	1.7fc	23.3ft	2.6fc	23.3ft	3.0fc	23.3ft	3.3fc	23.3ft	3.5fc	23.3ft
40ft	1.1fc	29.1ft	1.7fc	29.1ft	1.9fc	29.1ft	2.1fc	29.1ft	2.2fc	29.1ft
48ft	0.7fc	34.9ft	1.2fc	34.9ft	1.3fc	34.9ft	1.5fc	34.9ft	1.5fc	34.9ft
60ft	0.5fc	43.7ft	0.7fc	43.7ft	0.9fc	43.7ft	0.9fc	43.7ft	1.0fc	43.7ft

At 60° Setting



POWER	15W		22W		26W		30W		33W	
DISTANCE	FOOT CANDLES	BEAM WIDTH	FOOT CANDLES	BEAM WIDTH	FOOT CANDLES	BEAM WIDTH	FOOT CANDLES	BEAM WIDTH	FOOT CANDLES	BEAM WIDTH
4ft	50.1fc	4.6ft	79.4fc	4.6ft	91.6fc	4.6ft	100.1fc	4.6ft	105.4fc	4.6ft
8ft	12.5fc	9.2ft	19.8fc	9.2ft	22.9fc	9.2ft	25.0fc	9.2ft	26.3fc	9.2ft
12ft	5.6fc	13.9ft	8.8fc	13.9ft	10.2fc	13.9ft	11.1fc	13.9ft	11.7fc	13.9ft
16ft	3.1fc	18.5ft	5.0fc	18.5ft	5.7fc	18.5ft	6.3fc	18.5ft	6.6fc	18.5ft
24ft	1.4fc	27.7ft	2.2fc	27.7ft	2.5fc	27.7ft	2.8fc	27.7ft	2.9fc	27.7ft
32ft	0.8fc	37.0ft	1.2fc	37.0ft	1.4fc	37.0ft	1.6fc	37.0ft	1.6fc	37.0ft
40ft	0.5fc	46.2ft	0.8fc	46.2ft	0.9fc	46.2ft	1.0fc	46.2ft	1.1fc	46.2ft
48ft	0.3fc	55.4ft	0.6fc	55.4ft	0.6fc	55.4ft	0.7fc	55.4ft	0.7fc	55.4ft
60ft	0.2fc	69.3ft	0.4fc	69.3ft	0.4fc	69.3ft	0.4fc	69.3ft	0.5fc	69.3ft

GRAND ACCENT 120V PHOTOMETRICS

At 15° Setting	POWER	13W		16W		21W		26W		31W	
	DISTANCE	FOOT CANDLES	BEAM WIDTH	FOOT CANDLES	BEAM WIDTH	FOOT CANDLES	BEAM WIDTH	FOOT CANDLES	BEAM WIDTH	FOOT CANDLES	BEAM WIDTH
	4ft	298.8fc	1.1ft	356.4fc	1.1ft	457.7fc	1.1ft	541.1fc	1.1ft	613.5fc	1.1ft
	8ft	74.7fc	2.1ft	89.1fc	2.1ft	114.4fc	2.1ft	135.3fc	2.1ft	153.4fc	2.1ft
	12ft	33.2fc	3.2ft	39.6fc	3.2ft	50.9fc	3.2ft	60.1fc	3.2ft	68.2fc	3.2ft
	16ft	18.7fc	4.2ft	22.3fc	4.2ft	28.6fc	4.2ft	33.8fc	4.2ft	38.3fc	4.2ft
	24ft	8.3fc	6.3ft	9.9fc	6.3ft	12.7fc	6.3ft	15.0fc	6.3ft	17.0fc	6.3ft
	32ft	4.7fc	8.4ft	5.6fc	8.4ft	7.2fc	8.4ft	8.5fc	8.4ft	9.6fc	8.4ft
	40ft	3.0fc	10.5ft	3.6fc	10.5ft	4.6fc	10.5ft	5.4fc	10.5ft	6.1fc	10.5ft
	48ft	2.1fc	12.6ft	2.5fc	12.6ft	3.2fc	12.6ft	3.8fc	12.6ft	4.3fc	12.6ft
	60ft	1.3fc	15.8ft	1.6fc	15.8ft	2.0fc	15.8ft	2.4fc	15.8ft	2.7fc	15.8ft

At 25° Setting	POWER	13W		16W		21W		26W		31W	
	DISTANCE	FOOT CANDLES	BEAM WIDTH	FOOT CANDLES	BEAM WIDTH	FOOT CANDLES	BEAM WIDTH	FOOT CANDLES	BEAM WIDTH	FOOT CANDLES	BEAM WIDTH
	4ft	238.8fc	1.8ft	281.6fc	1.8ft	356.1fc	1.8ft	424.5fc	1.8ft	474.8fc	1.8ft
	8ft	59.7fc	3.5ft	70.4fc	3.5ft	89.0fc	3.5ft	106.1fc	3.5ft	118.7fc	3.5ft
	12ft	26.5fc	5.3ft	31.3fc	5.3ft	39.6fc	5.3ft	47.2fc	5.3ft	52.8fc	5.3ft
	16ft	14.9fc	7.1ft	17.6fc	7.1ft	22.3fc	7.1ft	26.5fc	7.1ft	29.7fc	7.1ft
	24ft	6.6fc	10.6ft	7.8fc	10.6ft	9.9fc	10.6ft	11.8fc	10.6ft	13.2fc	10.6ft
	32ft	3.7fc	14.2ft	4.4fc	14.2ft	5.6fc	14.2ft	6.6fc	14.2ft	7.4fc	14.2ft
	40ft	2.4fc	17.7ft	2.8fc	17.7ft	3.6fc	17.7ft	4.2fc	17.7ft	4.7fc	17.7ft
	48ft	1.7fc	21.3ft	2.0fc	21.3ft	2.5fc	21.3ft	2.9fc	21.3ft	3.3fc	21.3ft
	60ft	1.1fc	26.6ft	1.3fc	26.6ft	1.6fc	26.6ft	1.9fc	26.6ft	2.1fc	26.6ft

At 40° Setting	POWER	13W		16W		21W		26W		31W	
	DISTANCE	FOOT CANDLES	BEAM WIDTH	FOOT CANDLES	BEAM WIDTH	FOOT CANDLES	BEAM WIDTH	FOOT CANDLES	BEAM WIDTH	FOOT CANDLES	BEAM WIDTH
	4ft	113.6fc	2.9ft	136.1fc	2.9ft	175.2fc	2.9ft	204.2fc	2.9ft	234.2fc	2.9ft
	8ft	28.4fc	5.8ft	34.0fc	5.8ft	43.8fc	5.8ft	51.0fc	5.8ft	58.5fc	5.8ft
	12ft	12.6fc	8.7ft	15.1fc	8.7ft	19.5fc	8.7ft	22.7fc	8.7ft	26.0fc	8.7ft
	16ft	7.1fc	11.6ft	8.5fc	11.6ft	10.9fc	11.6ft	12.8fc	11.6ft	14.6fc	11.6ft
	24ft	3.2fc	17.5ft	3.8fc	17.5ft	4.9fc	17.5ft	5.7fc	17.5ft	6.5fc	17.5ft
	32ft	1.8fc	23.3ft	2.1fc	23.3ft	2.7fc	23.3ft	3.2fc	23.3ft	3.7fc	23.3ft
	40ft	1.1fc	29.1ft	1.4fc	29.1ft	1.8fc	29.1ft	2.0fc	29.1ft	2.3fc	29.1ft
	48ft	0.8fc	34.9ft	0.9fc	34.9ft	1.2fc	34.9ft	1.4fc	34.9ft	1.6fc	34.9ft
	60ft	0.5fc	43.7ft	0.6fc	43.7ft	0.8fc	43.7ft	0.9fc	43.7ft	1.0fc	43.7ft

At 60° Setting	POWER	13W		16W		21W		26W		31W	
	DISTANCE	FOOT CANDLES	BEAM WIDTH	FOOT CANDLES	BEAM WIDTH	FOOT CANDLES	BEAM WIDTH	FOOT CANDLES	BEAM WIDTH	FOOT CANDLES	BEAM WIDTH
	4ft	53.5fc	4.6ft	64.2fc	4.6ft	81.9fc	4.6ft	97.1fc	4.6ft	110.1fc	4.6ft
	8ft	13.4fc	9.2ft	16.0fc	9.2ft	20.5fc	9.2ft	24.3fc	9.2ft	27.5fc	9.2ft
	12ft	5.9fc	13.9ft	7.1fc	13.9ft	9.1fc	13.9ft	10.8fc	13.9ft	12.2fc	13.9ft
	16ft	3.3fc	18.5ft	4.0fc	18.5ft	5.1fc	18.5ft	6.1fc	18.5ft	6.9fc	18.5ft
	24ft	1.5fc	27.7ft	1.8fc	27.7ft	2.3fc	27.7ft	2.7fc	27.7ft	3.1fc	27.7ft
	32ft	0.8fc	37.0ft	1.0fc	37.0ft	1.3fc	37.0ft	1.5fc	37.0ft	1.7fc	37.0ft
	40ft	0.5fc	46.2ft	0.6fc	46.2ft	0.8fc	46.2ft	1.0fc	46.2ft	1.1fc	46.2ft
	48ft	0.4fc	55.4ft	0.4fc	55.4ft	0.6fc	55.4ft	0.7fc	55.4ft	0.8fc	55.4ft
	60ft	0.2fc	69.3ft	0.3fc	69.3ft	0.4fc	69.3ft	0.4fc	69.3ft	0.5fc	69.3ft

ACCENT 12V PHOTOMETRICS

At 10° Setting



POWER	1W		2W		8W		15W		18W	
DISTANCE	FOOT CANDLES	BEAM WIDTH	FOOT CANDLES	BEAM WIDTH	FOOT CANDLES	BEAM WIDTH	FOOT CANDLES	BEAM WIDTH	FOOT CANDLES	BEAM WIDTH
4ft	55.9fc	0.8ft	129.0fc	0.8ft	233.8fc	0.8ft	341.4fc	0.8ft	435.3fc	0.8ft
8ft	14.0fc	1.7ft	32.3fc	1.7ft	58.5fc	1.7ft	85.4fc	1.7ft	108.8fc	1.7ft
12ft	6.2fc	2.5ft	14.3fc	2.5ft	26.0fc	2.5ft	37.9fc	2.5ft	48.4fc	2.5ft
16ft	3.5fc	3.4ft	8.1fc	3.4ft	14.6fc	3.4ft	21.3fc	3.4ft	27.2fc	3.4ft
24ft	1.6fc	5.0ft	3.6fc	5.0ft	6.5fc	5.0ft	9.5fc	5.0ft	12.1fc	5.0ft
32ft	0.9fc	6.7ft	2.0fc	6.7ft	3.7fc	6.7ft	5.3fc	6.7ft	6.8fc	6.7ft
40ft	0.6fc	8.4ft	1.3fc	8.4ft	2.3fc	8.4ft	3.4fc	8.4ft	4.4fc	8.4ft
48ft	0.4fc	10.1ft	0.9fc	10.1ft	1.6fc	10.1ft	2.4fc	10.1ft	3.0fc	10.1ft
60ft	0.2fc	12.6ft	0.6fc	12.6ft	1.0fc	12.6ft	1.5fc	12.6ft	1.9fc	12.6ft

At 25° Setting



POWER	1W		2W		8W		15W		18W	
DISTANCE	FOOT CANDLES	BEAM WIDTH	FOOT CANDLES	BEAM WIDTH	FOOT CANDLES	BEAM WIDTH	FOOT CANDLES	BEAM WIDTH	FOOT CANDLES	BEAM WIDTH
4ft	25.2fc	1.8ft	54.8fc	1.8ft	105.8fc	1.8ft	153.0fc	1.8ft	194.6fc	1.8ft
8ft	6.3fc	3.5ft	13.7fc	3.5ft	26.5fc	3.5ft	38.3fc	3.5ft	48.7fc	3.5ft
12ft	2.8fc	5.3ft	6.1fc	5.3ft	11.8fc	5.3ft	17.0fc	5.3ft	21.6fc	5.3ft
16ft	1.6fc	7.1ft	3.4fc	7.1ft	6.6fc	7.1ft	9.6fc	7.1ft	12.2fc	7.1ft
24ft	0.7fc	10.6ft	1.5fc	10.6ft	2.9fc	10.6ft	4.3fc	10.6ft	5.4fc	10.6ft
32ft	0.4fc	14.2ft	0.9fc	14.2ft	1.7fc	14.2ft	2.4fc	14.2ft	3.0fc	14.2ft
40ft	0.3fc	17.7ft	0.5fc	17.7ft	1.1fc	17.7ft	1.5fc	17.7ft	1.9fc	17.7ft
48ft	0.2fc	21.3ft	0.4fc	21.3ft	0.7fc	21.3ft	1.1fc	21.3ft	1.4fc	21.3ft
60ft	0.1fc	26.6ft	0.2fc	26.6ft	0.5fc	26.6ft	0.7fc	26.6ft	0.9fc	26.6ft

At 40° Setting



POWER	1W		2W		8W		15W		18W	
DISTANCE	FOOT CANDLES	BEAM WIDTH	FOOT CANDLES	BEAM WIDTH	FOOT CANDLES	BEAM WIDTH	FOOT CANDLES	BEAM WIDTH	FOOT CANDLES	BEAM WIDTH
4ft	14.5fc	3.0ft	33.2fc	3.0ft	60.2fc	3.0ft	88.6fc	3.0ft	113.9fc	3.0ft
8ft	3.6fc	6.1ft	8.3fc	6.1ft	15.0fc	6.1ft	22.1fc	6.1ft	28.5fc	6.1ft
12ft	1.6fc	9.1ft	3.7fc	9.1ft	6.7fc	9.1ft	9.8fc	9.1ft	12.7fc	9.1ft
16ft	0.9fc	12.2ft	2.1fc	12.2ft	3.8fc	12.2ft	5.5fc	12.2ft	7.1fc	12.2ft
24ft	0.4fc	18.2ft	0.9fc	18.2ft	1.7fc	18.2ft	2.5fc	18.2ft	3.2fc	18.2ft
32ft	0.2fc	24.3ft	0.5fc	24.3ft	0.9fc	24.3ft	1.4fc	24.3ft	1.8fc	24.3ft
40ft	0.1fc	30.4ft	0.3fc	30.4ft	0.6fc	30.4ft	0.9fc	30.4ft	1.1fc	30.4ft
48ft	0.1fc	36.5ft	0.2fc	36.5ft	0.4fc	36.5ft	0.6fc	36.5ft	0.8fc	36.5ft
60ft	0.1fc	45.6ft	0.1fc	45.6ft	0.3fc	45.6ft	0.4fc	45.6ft	0.5fc	45.6ft

At 60° Setting



POWER	1W		2W		8W		15W		18W	
DISTANCE	FOOT CANDLES	BEAM WIDTH	FOOT CANDLES	BEAM WIDTH	FOOT CANDLES	BEAM WIDTH	FOOT CANDLES	BEAM WIDTH	FOOT CANDLES	BEAM WIDTH
4ft	9.0fc	4.5ft	16.6fc	4.5ft	41.2fc	4.5ft	54.0fc	4.5ft	70.1fc	4.5ft
8ft	2.3fc	8.9ft	4.1fc	8.9ft	10.3fc	8.9ft	13.5fc	8.9ft	17.5fc	8.9ft
12ft	1.0fc	13.4ft	1.8fc	13.4ft	4.6fc	13.4ft	6.0fc	13.4ft	7.8fc	13.4ft
16ft	0.6fc	17.9ft	1.0fc	17.9ft	2.6fc	17.9ft	3.4fc	17.9ft	4.4fc	17.9ft
24ft	0.3fc	26.8ft	0.5fc	26.8ft	1.1fc	26.8ft	1.5fc	26.8ft	1.9fc	26.8ft
32ft	0.1fc	35.8ft	0.3fc	35.8ft	0.6fc	35.8ft	0.8fc	35.8ft	1.1fc	35.8ft
40ft	0.1fc	44.7ft	0.2fc	44.7ft	0.4fc	44.7ft	0.5fc	44.7ft	0.7fc	44.7ft
48ft	0.1fc	53.7ft	0.1fc	53.7ft	0.3fc	53.7ft	0.4fc	53.7ft	0.5fc	53.7ft
60ft	0.0fc	67.1ft	0.1fc	67.1ft	0.2fc	67.1ft	0.2fc	67.1ft	0.3fc	67.1ft

ACCENT 120V PHOTOMETRICS

At 15° Setting



POWER	3.5W		6.5W		10.5W		13.5W		14.5W	
DISTANCE	FOOT CANDLES	BEAM WIDTH	FOOT CANDLES	BEAM WIDTH	FOOT CANDLES	BEAM WIDTH	FOOT CANDLES	BEAM WIDTH	FOOT CANDLES	BEAM WIDTH
4ft	50.4fc	1.1ft	102.4fc	1.1ft	151.8fc	1.1ft	192.9fc	1.1ft	200.3fc	1.1ft
8ft	12.6fc	2.1ft	25.6fc	2.1ft	37.9fc	2.1ft	48.2fc	2.1ft	50.1fc	2.1ft
12ft	5.6fc	3.2ft	11.4fc	3.2ft	16.9fc	3.2ft	21.4fc	3.2ft	22.3fc	3.2ft
16ft	3.1fc	4.2ft	6.4fc	4.2ft	9.5fc	4.2ft	12.1fc	4.2ft	12.5fc	4.2ft
24ft	1.4fc	6.3ft	2.8fc	6.3ft	4.2fc	6.3ft	5.4fc	6.3ft	5.6fc	6.3ft
32ft	0.8fc	8.4ft	1.6fc	8.4ft	2.4fc	8.4ft	3.0fc	8.4ft	3.1fc	8.4ft
40ft	0.5fc	10.5ft	1.0fc	10.5ft	1.5fc	10.5ft	1.9fc	10.5ft	2.0fc	10.5ft
48ft	0.3fc	12.6ft	0.7fc	12.6ft	1.1fc	12.6ft	1.3fc	12.6ft	1.4fc	12.6ft
60ft	0.2fc	15.8ft	0.5fc	15.8ft	0.7fc	15.8ft	0.9fc	15.8ft	0.9fc	15.8ft

At 25° Setting



POWER	3.5W		6.5W		10.5W		13.5W		14.5W	
DISTANCE	FOOT CANDLES	BEAM WIDTH	FOOT CANDLES	BEAM WIDTH	FOOT CANDLES	BEAM WIDTH	FOOT CANDLES	BEAM WIDTH	FOOT CANDLES	BEAM WIDTH
4ft	37.2fc	1.8ft	73.1fc	1.8ft	113.1fc	1.8ft	139.2fc	1.8ft	149.1fc	1.8ft
8ft	9.3fc	3.5ft	18.3fc	3.5ft	28.3fc	3.5ft	34.8fc	3.5ft	37.3fc	3.5ft
12ft	4.1fc	5.3ft	8.1fc	5.3ft	12.6fc	5.3ft	15.5fc	5.3ft	16.6fc	5.3ft
16ft	2.3fc	7.1ft	4.6fc	7.1ft	7.1fc	7.1ft	8.7fc	7.1ft	9.3fc	7.1ft
24ft	1.0fc	10.6ft	2.0fc	10.6ft	3.1fc	10.6ft	3.9fc	10.6ft	4.1fc	10.6ft
32ft	0.6fc	14.2ft	1.1fc	14.2ft	1.8fc	14.2ft	2.2fc	14.2ft	2.3fc	14.2ft
40ft	0.4fc	17.7ft	0.7fc	17.7ft	1.1fc	17.7ft	1.4fc	17.7ft	1.5fc	17.7ft
48ft	0.3fc	21.3ft	0.5fc	21.3ft	0.8fc	21.3ft	1.0fc	21.3ft	1.0fc	21.3ft
60ft	0.2fc	26.6ft	0.3fc	26.6ft	0.5fc	26.6ft	0.6fc	26.6ft	0.7fc	26.6ft

At 40° Setting



POWER	3.5W		6.5W		10.5W		13.5W		14.5W	
DISTANCE	FOOT CANDLES	BEAM WIDTH	FOOT CANDLES	BEAM WIDTH	FOOT CANDLES	BEAM WIDTH	FOOT CANDLES	BEAM WIDTH	FOOT CANDLES	BEAM WIDTH
4ft	20.7fc	3.0ft	36.7fc	3.0ft	63.4fc	3.0ft	81.9fc	3.0ft	85.9fc	3.0ft
8ft	5.2fc	6.1ft	9.2fc	6.1ft	15.8fc	6.1ft	20.5fc	6.1ft	21.5fc	6.1ft
12ft	2.3fc	9.1ft	4.1fc	9.1ft	7.0fc	9.1ft	9.1fc	9.1ft	9.5fc	9.1ft
16ft	1.3fc	12.2ft	2.3fc	12.2ft	4.0fc	12.2ft	5.1fc	12.2ft	5.4fc	12.2ft
24ft	0.6fc	18.2ft	1.0fc	18.2ft	1.8fc	18.2ft	2.3fc	18.2ft	2.4fc	18.2ft
32ft	0.3fc	24.3ft	0.6fc	24.3ft	1.0fc	24.3ft	1.3fc	24.3ft	1.3fc	24.3ft
40ft	0.2fc	30.4ft	0.4fc	30.4ft	0.6fc	30.4ft	0.8fc	30.4ft	0.9fc	30.4ft
48ft	0.1fc	36.5ft	0.3fc	36.5ft	0.4fc	36.5ft	0.6fc	36.5ft	0.6fc	36.5ft
60ft	0.1fc	45.6ft	0.2fc	45.6ft	0.3fc	45.6ft	0.4fc	45.6ft	0.4fc	45.6ft

At 60° Setting



POWER	3.5W		6.5W		10.5W		13.5W		14.5W	
DISTANCE	FOOT CANDLES	BEAM WIDTH	FOOT CANDLES	BEAM WIDTH	FOOT CANDLES	BEAM WIDTH	FOOT CANDLES	BEAM WIDTH	FOOT CANDLES	BEAM WIDTH
4ft	13.2fc	4.5ft	24.5fc	4.5ft	33.1fc	4.5ft	46.6fc	4.5ft	53.6fc	4.5ft
8ft	3.3fc	8.9ft	6.1fc	8.9ft	8.3fc	8.9ft	11.7fc	8.9ft	13.4fc	8.9ft
12ft	1.5fc	13.4ft	2.7fc	13.4ft	3.7fc	13.4ft	5.2fc	13.4ft	6.0fc	13.4ft
16ft	0.8fc	17.9ft	1.5fc	17.9ft	2.1fc	17.9ft	2.9fc	17.9ft	3.4fc	17.9ft
24ft	0.4fc	26.8ft	0.7fc	26.8ft	0.9fc	26.8ft	1.3fc	26.8ft	1.5fc	26.8ft
32ft	0.2fc	35.8ft	0.4fc	35.8ft	0.5fc	35.8ft	0.7fc	35.8ft	0.8fc	35.8ft
40ft	0.1fc	44.7ft	0.2fc	44.7ft	0.3fc	44.7ft	0.5fc	44.7ft	0.5fc	44.7ft
48ft	0.1fc	53.7ft	0.2fc	53.7ft	0.2fc	53.7ft	0.3fc	53.7ft	0.4fc	53.7ft
60ft	0.1fc	67.1ft	0.1fc	67.1ft	0.1fc	67.1ft	0.2fc	67.1ft	0.2fc	67.1ft

INTERBEAM 12V PHOTOMETRICS

5311

At 20° Setting

DISTANCE	POWER	6W	
		FOOT CANDLES	BEAM WIDTH
4ft		107.3fc	1.5ft
8ft		26.8fc	3.0ft
12ft		11.9fc	4.0ft
16ft		6.7fc	5.5ft
24ft		3.0fc	8.5ft
32ft		1.7fc	11.5ft
40ft		1.1fc	14.0ft
48ft		0.7fc	17.0ft
60ft		0.5fc	20.0ft

5411

At 20° Setting

DISTANCE	POWER	3W	
		FOOT CANDLES	BEAM WIDTH
4ft		51.3fc	1.5ft
8ft		12.8fc	3.0ft
12ft		5.7fc	4.0ft
16ft		3.2fc	5.5ft
24ft		1.4fc	8.5ft
32ft		0.8fc	11.5ft
40ft		0.5fc	14.0ft
48ft		0.4fc	17.0ft
60ft		0.2fc	21.0ft

At 35° Setting

DISTANCE	POWER	6W	
		FOOT CANDLES	BEAM WIDTH
4ft		61.9fc	2.5ft
8ft		15.5fc	5.0ft
12ft		2.7fc	6.4ft
16ft		6.9fc	7.5ft
24ft		3.9fc	10.0ft
32ft		1.7fc	15.0ft
40ft		1.0fc	20.0ft
48ft		0.4fc	30.5ft
60ft		0.3fc	38.0ft

At 35° Setting

DISTANCE	POWER	3W	
		FOOT CANDLES	BEAM WIDTH
4ft		32.3fc	2.5ft
8ft		8.1fc	5.0ft
12ft		3.6fc	7.5ft
16ft		2.0fc	10.0ft
24ft		0.9fc	15.0ft
32ft		0.5fc	20.0ft
40ft		0.3fc	25.0ft
48ft		0.2fc	30.5ft
60ft		0.1fc	38.0ft

At 60° Setting

DISTANCE	POWER	6W	
		FOOT CANDLES	BEAM WIDTH
4ft		34.4fc	4.5ft
8ft		8.6fc	9.0ft
12ft		3.8fc	14.0ft
16ft		2.2fc	18.5ft
24ft		1.0fc	27.5ft
32ft		0.5fc	37.0ft
40ft		0.3fc	46.0ft
48ft		0.2fc	55.5ft
60ft		0.2fc	69.5ft

At 60° Setting

DISTANCE	POWER	3W	
		FOOT CANDLES	BEAM WIDTH
4ft		15.4fc	4.5ft
8ft		3.8fc	9.0ft
12ft		1.7fc	14.0ft
16ft		1.0fc	18.5ft
24ft		0.4fc	27.5ft
32ft		0.2fc	37.0ft
40ft		0.2fc	46.0ft
48ft		0.1fc	55.5ft
60ft		0.1fc	69.5ft

HORNET 12V PHOTOMETRICS

5611

At 20° Setting

DISTANCE	POWER	10.5W	
		FOOT CANDLES	BEAM WIDTH
4ft		165.5fc	1.4ft
8ft		41.4fc	2.8ft
12ft		18.4fc	4.2ft
16ft		10.3fc	5.6ft
24ft		4.6fc	8.5ft
32ft		2.6fc	11.3ft
40ft		1.7fc	14.1ft
48ft		1.1fc	16.9ft
60ft		0.7fc	21.2ft

At 35° Setting

DISTANCE	POWER	10.5W	
		FOOT CANDLES	BEAM WIDTH
4ft		91.1fc	2.5ft
8ft		22.8fc	5.0ft
12ft		10.1fc	7.6ft
16ft		5.7fc	10.1ft
24ft		2.5fc	15.1ft
32ft		1.4fc	20.2ft
40ft		0.9fc	25.2ft
48ft		0.6fc	30.3ft
60ft		0.4fc	37.8ft

At 45° Setting

DISTANCE	POWER	10.5W	
		FOOT CANDLES	BEAM WIDTH
4ft		62.8fc	3.5ft
8ft		15.7fc	6.5ft
12ft		7.0fc	10.0ft
16ft		3.9fc	13.5ft
24ft		1.7fc	20.0ft
32ft		1.0fc	26.5ft
40ft		0.6fc	33.0ft
48ft		0.4fc	40.0ft
60ft		0.3fc	49.5ft

At 60° Setting

DISTANCE	POWER	10.5W	
		FOOT CANDLES	BEAM WIDTH
4ft		47.7fc	4.6ft
8ft		11.9fc	9.2ft
12ft		5.3fc	13.9ft
16ft		3.0fc	18.5ft
24ft		1.3fc	27.7ft
32ft		0.7fc	37.0ft
40ft		0.5fc	46.2ft
48ft		0.3fc	55.4ft
60ft		0.2fc	69.3ft

At 70° Setting

DISTANCE	POWER	10.5W	
		FOOT CANDLES	BEAM WIDTH
4ft		40.4fc	5.6ft
8ft		10.1fc	11.2ft
12ft		4.5fc	16.8ft
16ft		2.5fc	22.4ft
24ft		1.1fc	33.6ft
32ft		0.6fc	44.8ft
40ft		0.4fc	56.0ft
48ft		0.3fc	67.2ft
60ft		0.2fc	84.0ft

MINI ACCENT 12V PHOTOMETRICS

At 10° Setting



POWER	1W		2W		4W		6W		7W	
DISTANCE	FOOT CANDLES	BEAM WIDTH	FOOT CANDLES	BEAM WIDTH	FOOT CANDLES	BEAM WIDTH	FOOT CANDLES	BEAM WIDTH	FOOT CANDLES	BEAM WIDTH
4ft	83.1fc	0.6ft	122.8fc	0.6ft	181.0fc	0.6ft	244.1fc	0.6ft	274.9fc	0.6ft
8ft	20.8fc	1.2ft	30.7fc	1.2ft	45.3fc	1.2ft	61.0fc	1.2ft	68.7fc	1.2ft
12ft	9.2fc	1.8ft	13.6fc	1.8ft	20.1fc	1.8ft	27.1fc	1.8ft	30.5fc	1.8ft
16ft	5.2fc	2.3ft	7.7fc	2.3ft	11.3fc	2.3ft	15.3fc	2.3ft	17.2fc	2.3ft
24ft	2.3fc	3.5ft	3.4fc	3.5ft	5.0fc	3.5ft	6.8fc	3.5ft	7.6fc	3.5ft
32ft	1.3fc	4.7ft	1.9fc	4.7ft	2.8fc	4.7ft	3.8fc	4.7ft	4.3fc	4.7ft
40ft	0.8fc	5.9ft	1.2fc	5.9ft	1.8fc	5.9ft	2.4fc	5.9ft	2.7fc	5.9ft
48ft	0.6fc	7.0ft	0.9fc	7.0ft	1.3fc	7.0ft	1.7fc	7.0ft	1.9fc	7.0ft
60ft	0.4fc	8.8ft	0.5fc	8.8ft	0.8fc	8.8ft	1.1fc	8.8ft	1.2fc	8.8ft

At 25° Setting



POWER	1W		2W		4W		6W		7W	
DISTANCE	FOOT CANDLES	BEAM WIDTH	FOOT CANDLES	BEAM WIDTH	FOOT CANDLES	BEAM WIDTH	FOOT CANDLES	BEAM WIDTH	FOOT CANDLES	BEAM WIDTH
4ft	22.8fc	1.9ft	36.0fc	1.9ft	52.7fc	1.9ft	71.1fc	1.9ft	76.8fc	1.9ft
8ft	5.7fc	3.7ft	9.0fc	3.7ft	13.2fc	3.7ft	17.8fc	3.7ft	19.2fc	3.7ft
12ft	2.5fc	5.6ft	4.0fc	5.6ft	5.9fc	5.6ft	7.9fc	5.6ft	8.5fc	5.6ft
16ft	1.4fc	7.4ft	2.2fc	7.4ft	3.3fc	7.4ft	4.4fc	7.4ft	4.8fc	7.4ft
24ft	0.6fc	11.1ft	1.0fc	11.1ft	1.5fc	11.1ft	2.0fc	11.1ft	2.1fc	11.1ft
32ft	0.4fc	14.8ft	0.6fc	14.8ft	0.8fc	14.8ft	1.1fc	14.8ft	1.2fc	14.8ft
40ft	0.2fc	18.5ft	0.4fc	18.5ft	0.5fc	18.5ft	0.7fc	18.5ft	0.8fc	18.5ft
48ft	0.2fc	22.3ft	0.2fc	22.3ft	0.4fc	22.3ft	0.5fc	22.3ft	0.5fc	22.3ft
60ft	0.1fc	27.8ft	0.2fc	27.8ft	0.2fc	27.8ft	0.3fc	27.8ft	0.3fc	27.8ft

At 40° Setting



POWER	1W		2W		4W		6W		7W	
DISTANCE	FOOT CANDLES	BEAM WIDTH	FOOT CANDLES	BEAM WIDTH	FOOT CANDLES	BEAM WIDTH	FOOT CANDLES	BEAM WIDTH	FOOT CANDLES	BEAM WIDTH
4ft	13.0fc	3.1ft	20.7fc	3.1ft	27.7fc	3.1ft	39.6fc	3.1ft	42.0fc	3.1ft
8ft	3.3fc	6.1ft	5.2fc	6.1ft	6.9fc	6.1ft	9.9fc	6.1ft	10.5fc	6.1ft
12ft	1.4fc	9.2ft	2.3fc	9.2ft	3.1fc	9.2ft	4.4fc	9.2ft	4.7fc	9.2ft
16ft	0.8fc	12.3ft	1.3fc	12.3ft	1.7fc	12.3ft	2.5fc	12.3ft	2.6fc	12.3ft
24ft	0.4fc	18.4ft	0.6fc	18.4ft	0.8fc	18.4ft	1.1fc	18.4ft	1.2fc	18.4ft
32ft	0.2fc	24.5ft	0.3fc	24.5ft	0.4fc	24.5ft	0.6fc	24.5ft	0.7fc	24.5ft
40ft	0.1fc	30.6ft	0.2fc	30.6ft	0.3fc	30.6ft	0.4fc	30.6ft	0.4fc	30.6ft
48ft	0.1fc	36.8ft	0.1fc	36.8ft	0.2fc	36.8ft	0.3fc	36.8ft	0.3fc	36.8ft
60ft	0.1fc	45.9ft	0.1fc	45.9ft	0.1fc	45.9ft	0.2fc	45.9ft	0.2fc	45.9ft

At 50° Setting



POWER	1W		2W		4W		6W		7W	
DISTANCE	FOOT CANDLES	BEAM WIDTH	FOOT CANDLES	BEAM WIDTH	FOOT CANDLES	BEAM WIDTH	FOOT CANDLES	BEAM WIDTH	FOOT CANDLES	BEAM WIDTH
4ft	9.0fc	3.9ft	12.3fc	3.9ft	16.9fc	3.9ft	25.0fc	3.9ft	29.8fc	3.9ft
8ft	2.3fc	7.7ft	3.1fc	7.7ft	4.2fc	7.7ft	6.2fc	7.7ft	7.4fc	7.7ft
12ft	1.0fc	11.6ft	1.4fc	11.6ft	1.9fc	11.6ft	2.8fc	11.6ft	3.3fc	11.6ft
16ft	0.6fc	15.5ft	0.8fc	15.5ft	1.1fc	15.5ft	1.6fc	15.5ft	1.9fc	15.5ft
24ft	0.3fc	23.2ft	0.3fc	23.2ft	0.5fc	23.2ft	0.7fc	23.2ft	0.8fc	23.2ft
32ft	0.1fc	30.9ft	0.2fc	30.9ft	0.3fc	30.9ft	0.4fc	30.9ft	0.5fc	30.9ft
40ft	0.1fc	38.7ft	0.1fc	38.7ft	0.2fc	38.7ft	0.2fc	38.7ft	0.3fc	38.7ft
48ft	0.1fc	46.4ft	0.1fc	46.4ft	0.1fc	46.4ft	0.2fc	46.4ft	0.2fc	46.4ft
60ft	0.0fc	58.0ft	0.1fc	58.0ft	0.1fc	58.0ft	0.1fc	58.0ft	0.1fc	58.0ft

3" INGROUND 12V PHOTOMETRICS

At 15° Setting



POWER	1W		2W		7W		13W		14W	
DISTANCE	FOOT CANDLES	BEAM WIDTH	FOOT CANDLES	BEAM WIDTH	FOOT CANDLES	BEAM WIDTH	FOOT CANDLES	BEAM WIDTH	FOOT CANDLES	BEAM WIDTH
4ft	47.2fc	1.1ft	75.8fc	1.1ft	165.3fc	1.1ft	236.2fc	1.1ft	283.4fc	1.1ft
8ft	11.8fc	2.1ft	18.9fc	2.1ft	41.3fc	2.1ft	59.0fc	2.1ft	70.9fc	2.1ft
12ft	5.2fc	3.2ft	8.4fc	3.2ft	18.4fc	3.2ft	26.2fc	3.2ft	31.5fc	3.2ft
16ft	3.0fc	4.2ft	4.7fc	4.2ft	10.3fc	4.2ft	14.8fc	4.2ft	17.7fc	4.2ft
24ft	1.3fc	6.3ft	2.1fc	6.3ft	4.6fc	6.3ft	6.6fc	6.3ft	7.9fc	6.3ft
32ft	0.7fc	8.4ft	1.2fc	8.4ft	2.6fc	8.4ft	3.7fc	8.4ft	4.4fc	8.4ft
40ft	0.5fc	10.5ft	0.8fc	10.5ft	1.7fc	10.5ft	2.4fc	10.5ft	2.8fc	10.5ft
48ft	0.3fc	12.6ft	0.5fc	12.6ft	1.1fc	12.6ft	1.6fc	12.6ft	2.0fc	12.6ft
60ft	0.2fc	15.8ft	0.3fc	15.8ft	0.7fc	15.8ft	1.0fc	15.8ft	1.3fc	15.8ft

At 30° Setting



POWER	1W		2W		7W		13W		14W	
DISTANCE	FOOT CANDLES	BEAM WIDTH	FOOT CANDLES	BEAM WIDTH	FOOT CANDLES	BEAM WIDTH	FOOT CANDLES	BEAM WIDTH	FOOT CANDLES	BEAM WIDTH
4ft	19.4fc	2.1ft	38.8fc	2.1ft	68.0fc	2.1ft	97.1fc	2.1ft	116.6fc	2.1ft
8ft	4.9fc	4.3ft	9.7fc	4.3ft	17.0fc	4.3ft	24.3fc	4.3ft	29.1fc	4.3ft
12ft	2.2fc	6.4ft	4.3fc	6.4ft	7.6fc	6.4ft	10.8fc	6.4ft	13.0fc	6.4ft
16ft	1.2fc	8.6ft	2.4fc	8.6ft	4.3fc	8.6ft	6.1fc	8.6ft	7.3fc	8.6ft
24ft	0.5fc	12.9ft	1.1fc	12.9ft	1.9fc	12.9ft	2.7fc	12.9ft	3.2fc	12.9ft
32ft	0.3fc	17.1ft	0.6fc	17.1ft	1.1fc	17.1ft	1.5fc	17.1ft	1.8fc	17.1ft
40ft	0.2fc	21.4ft	0.4fc	21.4ft	0.7fc	21.4ft	1.0fc	21.4ft	1.2fc	21.4ft
48ft	0.1fc	25.7ft	0.3fc	25.7ft	0.5fc	25.7ft	0.7fc	25.7ft	0.8fc	25.7ft
60ft	0.1fc	32.2ft	0.2fc	32.2ft	0.3fc	32.2ft	0.4fc	32.2ft	0.5fc	32.2ft

At 45° Setting



POWER	1W		2W		7W		13W		14W	
DISTANCE	FOOT CANDLES	BEAM WIDTH	FOOT CANDLES	BEAM WIDTH	FOOT CANDLES	BEAM WIDTH	FOOT CANDLES	BEAM WIDTH	FOOT CANDLES	BEAM WIDTH
4ft	10.9fc	3.3ft	21.8fc	3.3ft	38.1fc	3.3ft	54.4fc	3.3ft	65.3fc	3.3ft
8ft	2.7fc	6.6ft	5.4fc	6.6ft	9.5fc	6.6ft	13.6fc	6.6ft	16.3fc	6.6ft
12ft	1.2fc	9.9ft	2.4fc	9.9ft	4.2fc	9.9ft	6.0fc	9.9ft	7.3fc	9.9ft
16ft	0.7fc	13.3ft	1.4fc	13.3ft	2.4fc	13.3ft	3.4fc	13.3ft	4.1fc	13.3ft
24ft	0.3fc	19.9ft	0.6fc	19.9ft	1.1fc	19.9ft	1.5fc	19.9ft	1.8fc	19.9ft
32ft	0.2fc	26.5ft	0.3fc	26.5ft	0.6fc	26.5ft	0.9fc	26.5ft	1.0fc	26.5ft
40ft	0.1fc	33.1ft	0.2fc	33.1ft	0.4fc	33.1ft	0.5fc	33.1ft	0.7fc	33.1ft
48ft	0.1fc	39.8ft	0.2fc	39.8ft	0.3fc	39.8ft	0.4fc	39.8ft	0.5fc	39.8ft
60ft	0.0fc	49.7ft	0.1fc	49.7ft	0.2fc	49.7ft	0.2fc	49.7ft	0.3fc	49.7ft

At 60° Setting



POWER	1W		2W		7W		13W		14W	
DISTANCE	FOOT CANDLES	BEAM WIDTH	FOOT CANDLES	BEAM WIDTH	FOOT CANDLES	BEAM WIDTH	FOOT CANDLES	BEAM WIDTH	FOOT CANDLES	BEAM WIDTH
4ft	7.3fc	4.6ft	14.5fc	4.6ft	25.4fc	4.6ft	36.3fc	4.6ft	43.6fc	4.6ft
8ft	1.8fc	9.2ft	3.6fc	9.2ft	6.4fc	9.2ft	9.1fc	9.2ft	10.9fc	9.2ft
12ft	0.8fc	13.9ft	1.6fc	13.9ft	2.8fc	13.9ft	4.0fc	13.9ft	4.8fc	13.9ft
16ft	0.5fc	18.5ft	0.9fc	18.5ft	1.6fc	18.5ft	2.3fc	18.5ft	2.7fc	18.5ft
24ft	0.2fc	27.7ft	0.4fc	27.7ft	0.7fc	27.7ft	1.0fc	27.7ft	1.2fc	27.7ft
32ft	0.1fc	37.0ft	0.2fc	37.0ft	0.4fc	37.0ft	0.6fc	37.0ft	0.7fc	37.0ft
40ft	0.1fc	46.2ft	0.1fc	46.2ft	0.3fc	46.2ft	0.4fc	46.2ft	0.4fc	46.2ft
48ft	0.1fc	55.4ft	0.1fc	55.4ft	0.2fc	55.4ft	0.3fc	55.4ft	0.3fc	55.4ft
60ft	0.0fc	69.3ft	0.1fc	69.3ft	0.1fc	69.3ft	0.2fc	69.3ft	0.2fc	69.3ft

3" INGROUND 120V PHOTOMETRICS

At 15° Setting



POWER	3W		5.5W		8.5W		10.5W		11.5W	
DISTANCE	FOOT CANDLES	BEAM WIDTH	FOOT CANDLES	BEAM WIDTH	FOOT CANDLES	BEAM WIDTH	FOOT CANDLES	BEAM WIDTH	FOOT CANDLES	BEAM WIDTH
4ft	44.4fc	1.1ft	81.1fc	1.1ft	125.4fc	1.1ft	154.9fc	1.1ft	169.6fc	1.1ft
8ft	11.1fc	2.1ft	20.3fc	2.1ft	31.3fc	2.1ft	38.7fc	2.1ft	42.4fc	2.1ft
12ft	4.9fc	3.2ft	9.0fc	3.2ft	13.9fc	3.2ft	17.2fc	3.2ft	18.8fc	3.2ft
16ft	2.8fc	4.2ft	5.1fc	4.2ft	7.8fc	4.2ft	9.7fc	4.2ft	10.6fc	4.2ft
24ft	1.2fc	6.3ft	2.3fc	6.3ft	3.5fc	6.3ft	4.3fc	6.3ft	4.7fc	6.3ft
32ft	0.7fc	8.4ft	1.3fc	8.4ft	2.0fc	8.4ft	2.4fc	8.4ft	2.7fc	8.4ft
40ft	0.4fc	10.5ft	0.8fc	10.5ft	1.3fc	10.5ft	1.5fc	10.5ft	1.7fc	10.5ft
48ft	0.3fc	12.6ft	0.6fc	12.6ft	0.9fc	12.6ft	1.1fc	12.6ft	1.2fc	12.6ft
60ft	0.2fc	15.8ft	0.4fc	15.8ft	0.6fc	15.8ft	0.7fc	15.8ft	0.8fc	15.8ft

At 30° Setting



POWER	15W		22W		26W		30W		33W	
DISTANCE	FOOT CANDLES	BEAM WIDTH	FOOT CANDLES	BEAM WIDTH	FOOT CANDLES	BEAM WIDTH	FOOT CANDLES	BEAM WIDTH	FOOT CANDLES	BEAM WIDTH
4ft	24.5fc	2.1ft	45.1fc	2.1ft	69.6fc	2.1ft	86.0fc	2.1ft	94.2fc	2.1ft
8ft	6.1fc	4.3ft	11.3fc	4.3ft	17.4fc	4.3ft	21.5fc	4.3ft	23.5fc	4.3ft
12ft	2.7fc	6.4ft	5.0fc	6.4ft	7.7fc	6.4ft	9.6fc	6.4ft	10.5fc	6.4ft
16ft	1.5fc	8.6ft	2.8fc	8.6ft	4.4fc	8.6ft	5.4fc	8.6ft	5.9fc	8.6ft
24ft	0.7fc	12.9ft	1.3fc	12.9ft	1.9fc	12.9ft	2.4fc	12.9ft	2.6fc	12.9ft
32ft	0.4fc	17.1ft	0.7fc	17.1ft	1.1fc	17.1ft	1.3fc	17.1ft	1.5fc	17.1ft
40ft	0.2fc	21.4ft	0.5fc	21.4ft	0.7fc	21.4ft	0.9fc	21.4ft	0.9fc	21.4ft
48ft	0.2fc	25.7ft	0.3fc	25.7ft	0.5fc	25.7ft	0.6fc	25.7ft	0.7fc	25.7ft
60ft	0.1fc	32.2ft	0.2fc	32.2ft	0.3fc	32.2ft	0.4fc	32.2ft	0.4fc	32.2ft

At 45° Setting



POWER	15W		22W		26W		30W		33W	
DISTANCE	FOOT CANDLES	BEAM WIDTH	FOOT CANDLES	BEAM WIDTH	FOOT CANDLES	BEAM WIDTH	FOOT CANDLES	BEAM WIDTH	FOOT CANDLES	BEAM WIDTH
4ft	16.2fc	3.3ft	29.9fc	3.3ft	46.2fc	3.3ft	57.0fc	3.3ft	62.5fc	3.3ft
8ft	4.1fc	6.6ft	7.5fc	6.6ft	11.5fc	6.6ft	14.3fc	6.6ft	15.6fc	6.6ft
12ft	1.8fc	9.9ft	3.3fc	9.9ft	5.1fc	9.9ft	6.3fc	9.9ft	6.9fc	9.9ft
16ft	1.0fc	13.3ft	1.9fc	13.3ft	2.9fc	13.3ft	3.6fc	13.3ft	3.9fc	13.3ft
24ft	0.5fc	19.9ft	0.8fc	19.9ft	1.3fc	19.9ft	1.6fc	19.9ft	1.7fc	19.9ft
32ft	0.3fc	26.5ft	0.5fc	26.5ft	0.7fc	26.5ft	0.9fc	26.5ft	1.0fc	26.5ft
40ft	0.2fc	33.1ft	0.3fc	33.1ft	0.5fc	33.1ft	0.6fc	33.1ft	0.6fc	33.1ft
48ft	0.1fc	39.8ft	0.2fc	39.8ft	0.3fc	39.8ft	0.4fc	39.8ft	0.4fc	39.8ft
60ft	0.1fc	49.7ft	0.1fc	49.7ft	0.2fc	49.7ft	0.3fc	49.7ft	0.3fc	49.7ft

At 60° Setting



POWER	15W		22W		26W		30W		33W	
DISTANCE	FOOT CANDLES	BEAM WIDTH	FOOT CANDLES	BEAM WIDTH	FOOT CANDLES	BEAM WIDTH	FOOT CANDLES	BEAM WIDTH	FOOT CANDLES	BEAM WIDTH
4ft	10.6fc	4.6ft	19.5fc	4.6ft	30.1fc	4.6ft	37.1fc	4.6ft	40.7fc	4.6ft
8ft	2.6fc	9.2ft	4.9fc	9.2ft	7.5fc	9.2ft	9.3fc	9.2ft	10.2fc	9.2ft
12ft	1.2fc	13.9ft	2.2fc	13.9ft	3.3fc	13.9ft	4.1fc	13.9ft	4.5fc	13.9ft
16ft	0.7fc	18.5ft	1.2fc	18.5ft	1.9fc	18.5ft	2.3fc	18.5ft	2.5fc	18.5ft
24ft	0.3fc	27.7ft	0.5fc	27.7ft	0.8fc	27.7ft	1.0fc	27.7ft	1.1fc	27.7ft
32ft	0.2fc	37.0ft	0.3fc	37.0ft	0.5fc	37.0ft	0.6fc	37.0ft	0.6fc	37.0ft
40ft	0.1fc	46.2ft	0.2fc	46.2ft	0.3fc	46.2ft	0.4fc	46.2ft	0.4fc	46.2ft
48ft	0.1fc	55.4ft	0.1fc	55.4ft	0.2fc	55.4ft	0.3fc	55.4ft	0.3fc	55.4ft
60ft	0.0fc	69.3ft	0.1fc	69.3ft	0.1fc	69.3ft	0.2fc	69.3ft	0.2fc	69.3ft

GRAND INGROUND 12V PHOTOMETRICS

At 20° Setting



DISTANCE	5W		9W		14W		20W		25W	
	FOOT CANDLES	BEAM WIDTH	FOOT CANDLES	BEAM WIDTH	FOOT CANDLES	BEAM WIDTH	FOOT CANDLES	BEAM WIDTH	FOOT CANDLES	BEAM WIDTH
4ft	99.3fc	1.5ft	161.6fc	1.5ft	263.5fc	1.5ft	375.3fc	1.5ft	445.1fc	1.5ft
8ft	24.8fc	3.0ft	40.4fc	3.0ft	65.9fc	3.0ft	93.8fc	3.0ft	111.3fc	3.0ft
12ft	11.0fc	4.0ft	18.0fc	4.0ft	29.3fc	4.0ft	41.7fc	4.0ft	49.5fc	4.0ft
16ft	6.2fc	5.5ft	10.1fc	5.5ft	16.5fc	5.5ft	23.5fc	5.5ft	27.8fc	5.5ft
24ft	2.8fc	8.5ft	4.5fc	8.5ft	7.3fc	8.5ft	10.4fc	8.5ft	12.4fc	8.5ft
32ft	1.6fc	11.5ft	2.5fc	11.5ft	4.1fc	11.5ft	5.9fc	11.5ft	7.0fc	11.5ft
40ft	1.0fc	14.0ft	1.6fc	14.0ft	2.6fc	14.0ft	3.8fc	14.0ft	4.5fc	14.0ft
48ft	0.7fc	17.0ft	1.1fc	17.0ft	1.8fc	17.0ft	2.6fc	17.0ft	3.1fc	17.0ft
60ft	0.4fc	21.0ft	0.7fc	21.0ft	1.2fc	21.0ft	1.7fc	21.0ft	2.0fc	21.0ft

At 30° Setting



DISTANCE	5W		9W		14W		20W		25W	
	FOOT CANDLES	BEAM WIDTH	FOOT CANDLES	BEAM WIDTH	FOOT CANDLES	BEAM WIDTH	FOOT CANDLES	BEAM WIDTH	FOOT CANDLES	BEAM WIDTH
4ft	77.8fc	2.0ft	135.3fc	2.0ft	213.8fc	2.0ft	313.6fc	2.0ft	350.4fc	2.0ft
8ft	19.5fc	4.5ft	33.8fc	4.5ft	53.4fc	4.5ft	78.4fc	4.5ft	87.6fc	4.5ft
12ft	8.6fc	6.5ft	15.0fc	6.5ft	23.8fc	6.5ft	34.8fc	6.5ft	38.9fc	6.5ft
16ft	4.9fc	8.5ft	8.5fc	8.5ft	13.4fc	8.5ft	19.6fc	8.5ft	21.9fc	8.5ft
24ft	2.2fc	13.0ft	3.8fc	13.0ft	5.9fc	13.0ft	8.7fc	13.0ft	9.7fc	13.0ft
32ft	1.2fc	17.0ft	2.1fc	17.0ft	3.3fc	17.0ft	4.9fc	17.0ft	5.5fc	17.0ft
40ft	0.8fc	21.5ft	1.4fc	21.5ft	2.1fc	21.5ft	3.1fc	21.5ft	3.5fc	21.5ft
48ft	0.5fc	25.5ft	0.9fc	25.5ft	1.5fc	25.5ft	2.2fc	25.5ft	2.4fc	25.5ft
60ft	0.3fc	32.0ft	0.6fc	32.0ft	1.0fc	32.0ft	1.4fc	32.0ft	1.6fc	32.0ft

At 40° Setting



DISTANCE	5W		9W		14W		20W		25W	
	FOOT CANDLES	BEAM WIDTH	FOOT CANDLES	BEAM WIDTH	FOOT CANDLES	BEAM WIDTH	FOOT CANDLES	BEAM WIDTH	FOOT CANDLES	BEAM WIDTH
4ft	52.1fc	3.0ft	86.0fc	3.0ft	136.3fc	3.0ft	198.5fc	3.0ft	220.6fc	3.0ft
8ft	13.0fc	6.0ft	21.5fc	6.1ft	34.1fc	6.1ft	49.6fc	6.1ft	55.1fc	6.1ft
12ft	5.8fc	8.5ft	9.6fc	9.1ft	15.1fc	9.1ft	22.1fc	9.1ft	24.5fc	9.1ft
16ft	3.3fc	11.5ft	5.4fc	12.2ft	8.5fc	12.2ft	12.4fc	12.2ft	13.8fc	12.2ft
24ft	1.4fc	17.5ft	2.4fc	18.2ft	3.8fc	18.2ft	5.5fc	18.2ft	6.1fc	18.2ft
32ft	0.8fc	23.5ft	1.3fc	24.3ft	2.1fc	24.3ft	3.1fc	24.3ft	3.4fc	24.3ft
40ft	0.5fc	29.0ft	0.9fc	30.4ft	1.4fc	30.4ft	2.0fc	30.4ft	2.2fc	30.4ft
48ft	0.4fc	35.0ft	0.6fc	36.5ft	0.9fc	36.5ft	1.4fc	36.5ft	1.5fc	36.5ft
60ft	0.2fc	43.5ft	0.4fc	45.6ft	0.6fc	45.6ft	0.9fc	45.6ft	1.0fc	45.6ft

At 50° Setting



DISTANCE	5W		9W		14W		20W		25W	
	FOOT CANDLES	BEAM WIDTH	FOOT CANDLES	BEAM WIDTH	FOOT CANDLES	BEAM WIDTH	FOOT CANDLES	BEAM WIDTH	FOOT CANDLES	BEAM WIDTH
4ft	37.1fc	3.5ft	61.1fc	3.5ft	100.1fc	3.5ft	140.5fc	3.5ft	161.1fc	3.5ft
8ft	9.3fc	7.5ft	15.3fc	7.5ft	25.0fc	7.5ft	35.1fc	7.5ft	40.3fc	7.5ft
12ft	4.1fc	11.0ft	6.8fc	11.0ft	11.1fc	11.0ft	15.6fc	11.0ft	17.9fc	11.0ft
16ft	2.3fc	15.0ft	3.8fc	15.0ft	6.3fc	15.0ft	8.8fc	15.0ft	10.1fc	15.0ft
24ft	1.0fc	22.5ft	1.7fc	22.5ft	2.8fc	22.5ft	3.9fc	22.5ft	4.5fc	22.5ft
32ft	0.6fc	30.0ft	1.0fc	30.0ft	1.6fc	30.0ft	2.2fc	30.0ft	2.5fc	30.0ft
40ft	0.4fc	37.5ft	0.6fc	37.5ft	1.0fc	37.5ft	1.4fc	37.5ft	1.6fc	37.5ft
48ft	0.3fc	45.0ft	0.4fc	45.0ft	0.7fc	45.0ft	1.0fc	45.0ft	1.1fc	45.0ft
60ft	0.2fc	56.0ft	0.3fc	56.0ft	0.4fc	56.0ft	0.6fc	56.0ft	0.7fc	56.0ft

At 60° Setting



DISTANCE	5W		9W		14W		20W		25W	
	FOOT CANDLES	BEAM WIDTH	FOOT CANDLES	BEAM WIDTH	FOOT CANDLES	BEAM WIDTH	FOOT CANDLES	BEAM WIDTH	FOOT CANDLES	BEAM WIDTH
4ft	28.9fc	4.5ft	47.6fc	4.5ft	76.7fc	4.5ft	111.2fc	4.5ft	124.7fc	4.5ft
8ft	7.2fc	9.0ft	11.9fc	9.0ft	19.2fc	9.0ft	27.8fc	9.0ft	31.2fc	9.0ft
12ft	3.2fc	14.0ft	5.3fc	14.0ft	8.5fc	14.0ft	12.4fc	14.0ft	13.9fc	14.0ft
16ft	1.8fc	18.5ft	3.0fc	18.5ft	4.8fc	18.5ft	6.9fc	18.5ft	7.8fc	18.5ft
24ft	0.8fc	27.5ft	1.3fc	27.5ft	2.1fc	27.5ft	3.1fc	27.5ft	3.5fc	27.5ft
32ft	0.5fc	37.0ft	0.7fc	37.0ft	1.2fc	37.0ft	1.7fc	37.0ft	1.9fc	37.0ft
40ft	0.3fc	46.0ft	0.5fc	46.0ft	0.8fc	46.0ft	1.1fc	46.0ft	1.2fc	46.0ft
48ft	0.2fc	55.5ft	0.3fc	55.5ft	0.5fc	55.5ft	0.8fc	55.5ft	0.9fc	55.5ft
60ft	0.1fc	69.5ft	0.2fc	69.5ft	0.3fc	69.5ft	0.5fc	69.5ft	0.6fc	69.5ft

HARDSCAPE PHOTOMETRICS

7032

Mounting Height	Distance from Fixture				
	0	1'	2'	3'	4'
12"	12.73fc	2.88fc	0.42fc	0.09fc	0.03fc
24"	3.16fc	1.95fc	0.73fc	0.26fc	0.10fc
36"	1.39fc	1.11fc	0.65fc	0.33fc	0.16fc

7062

Mounting Height	Distance from Fixture				
	0	1'	2'	3'	4'
12"	36.23fc	8.55fc	1.21fc	0.28fc	0.09fc
24"	9.29fc	5.76fc	2.14fc	0.75fc	0.30fc
36"	4.18fc	3.34fc	1.86fc	0.93fc	0.47fc

7122

Mounting Height	Distance from Fixture				
	0	1'	2'	3'	4'
12"	64.85fc	15.61fc	2.42fc	0.57fc	0.19fc
24"	16.35fc	10.31fc	3.90fc	1.49fc	0.61fc
36"	7.25fc	5.85fc	3.44fc	1.77fc	0.91fc

7182

Mounting Height	Distance from Fixture				
	0	1'	2'	3'	4'
12"	90.67fc	22.67fc	3.34fc	0.76fc	0.24fc
24"	23.13fc	14.68fc	5.57fc	2.04fc	0.82fc
36"	10.31fc	8.36fc	4.83fc	2.42fc	1.21fc

DECK & PATIO PHOTOMETRICS

3011

Mounting Height	Distance from Fixture						
	0	0.5'	1'	2'	3'	4'	5'
6"	6.79fc	82fc	2.65fc	0.15fc	0.03fc	0.01fc	0.01fc
12"	15fc	39fc	9.9fc	0.42fc	0.09fc	0.03fc	0.02fc
30"	5.79fc	7.21fc	6.35fc	2.17fc	0.43fc	0.14fc	0.06fc

3021

Mounting Height	Distance from Fixture						
	0	0.5'	1'	2'	3'	4'	5'
6"	16fc	74fc	0.92fc	0.04fc	0.01fc	-	-
12"	21fc	38fc	7.29fc	0.18fc	0.03fc	0.01fc	-
30"	5.86fc	7.2fc	5.97fc	1.85fc	0.24fc	0.07fc	0.03fc

3031

Mounting Height	Distance from Fixture						
	0	0.5'	1'	2'	3'	4'	5'
6"	15fc	117fc	1.6fc	0.11fc	0.03fc	0.01fc	0.01fc
12"	15fc	43fc	19fc	0.26fc	0.07fc	0.03fc	0.01fc
30"	5.1fc	7.22fc	7fc	3.95fc	0.49fc	0.09fc	0.04fc

WALL WASH PHOTOMETRICS

FIXTURE	MOUNTING DISTANCE (d)	A	B	C	D	E	F
5021-30	3ft	27.5fc	16.3fc	10.9fc	4.7fc	0.72fc	0.33fc
	4ft	15.6fc	9.6fc	5.9fc	2.7fc	0.40fc	0.18fc
	5ft	10fc	5.9fc	4.0fc	1.3fc	0.26fc	0.12fc
	6ft	6.8fc	4.1fc	2.7fc	1.2fc	0.18fc	0.08fc
	7ft	5fc	3.1fc	2.0fc	0.88fc	0.13fc	0.06fc
	8ft	3.9fc	2.4fc	1.6fc	0.67fc	0.10fc	0.05fc
	9ft	3.1fc	1.8fc	1.2fc	0.54fc	0.08fc	0.04fc
10ft	2.5fc	1.5fc	0.99fc	0.44fc	0.06fc	0.03fc	

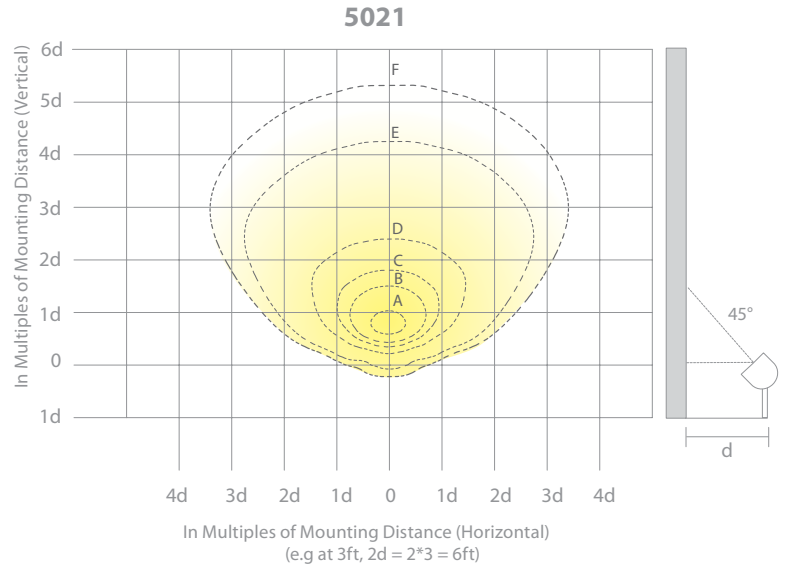

FIXTURE	MOUNTING DISTANCE (d)	A	B	C	D	E	F
5022-30	3ft	27.5fc	16.3fc	10.9fc	4.7fc	0.72fc	0.33fc
	4ft	15.6fc	9.6fc	5.9fc	2.7fc	0.40fc	0.18fc
	5ft	10fc	5.9fc	4.0fc	1.3fc	0.26fc	0.12fc
	6ft	6.8fc	4.1fc	2.7fc	1.2fc	0.18fc	0.08fc
	7ft	5fc	3.1fc	2.0fc	0.88fc	0.13fc	0.06fc
	8ft	3.9fc	2.4fc	1.6fc	0.67fc	0.10fc	0.05fc
	9ft	3.1fc	1.8fc	1.2fc	0.54fc	0.08fc	0.04fc
10ft	2.5fc	1.5fc	0.99fc	0.44fc	0.06fc	0.03fc	

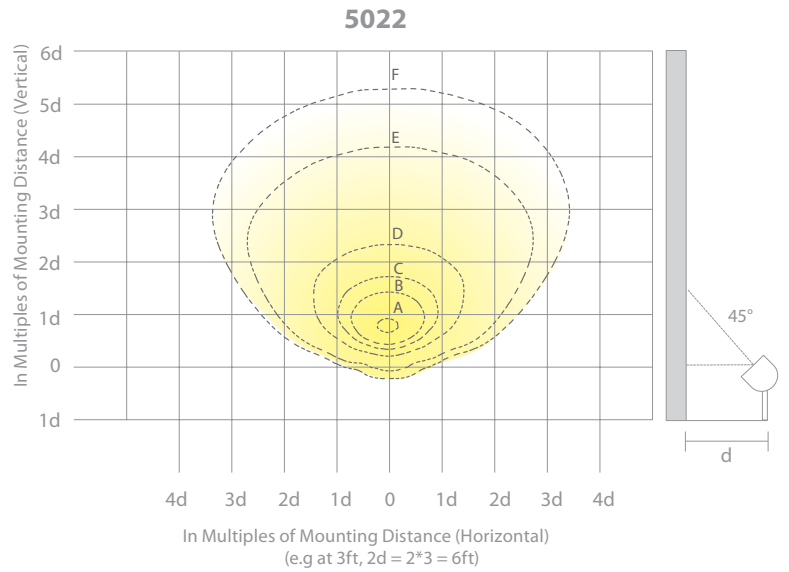

FIXTURE	MOUNTING DISTANCE (d)	A	B	C	D	E	F
5121-30	3ft	27.5fc	16.3fc	10.9fc	4.7fc	0.72fc	0.33fc
	4ft	15.6fc	9.6fc	5.9fc	2.7fc	0.40fc	0.18fc
	5ft	10fc	5.9fc	4.0fc	1.3fc	0.26fc	0.12fc
	6ft	6.8fc	4.1fc	2.7fc	1.2fc	0.18fc	0.08fc
	7ft	5fc	3.1fc	2.0fc	0.88fc	0.13fc	0.06fc
	8ft	3.9fc	2.4fc	1.6fc	0.67fc	0.10fc	0.05fc
	9ft	3.1fc	1.8fc	1.2fc	0.54fc	0.08fc	0.04fc
10ft	2.5fc	1.5fc	0.99fc	0.44fc	0.06fc	0.03fc	

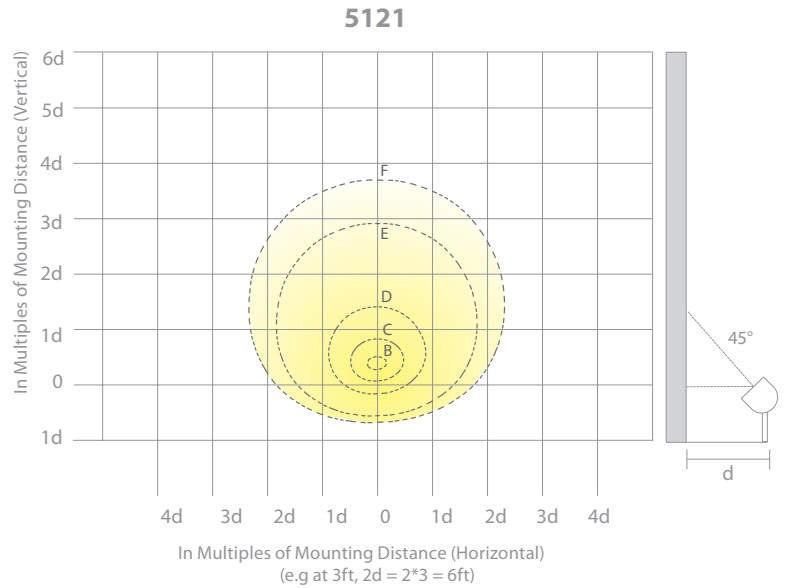

ADJUSTABLE BEAM WALL WASH PHOTOMETRICS

FIXTURE	MOUNTING DISTANCE (d)	A	B	C	D	E	F
5221/5222 (4X3)	3ft	27.9fc	11.3fc	5.6fc	1.5fc	0.05fc	0.02fc
	4ft	15.7fc	6.3fc	3.2fc	0.85fc	0.03fc	0.01fc
	5ft	10.1fc	4.1fc	2fc	0.53fc	0.02fc	0.01fc
	6ft	7fc	2.8fc	1.4fc	0.37fc	0.01fc	-
	7ft	5.1fc	2.1fc	1fc	0.28fc	0.01fc	-
	8ft	4fc	1.6fc	0.79fc	0.21fc	0.01fc	-
	9ft	3.1fc	1.3fc	0.62fc	0.17fc	0.01fc	-
10ft	2.5fc	1.0fc	0.51fc	0.14fc	-	-	

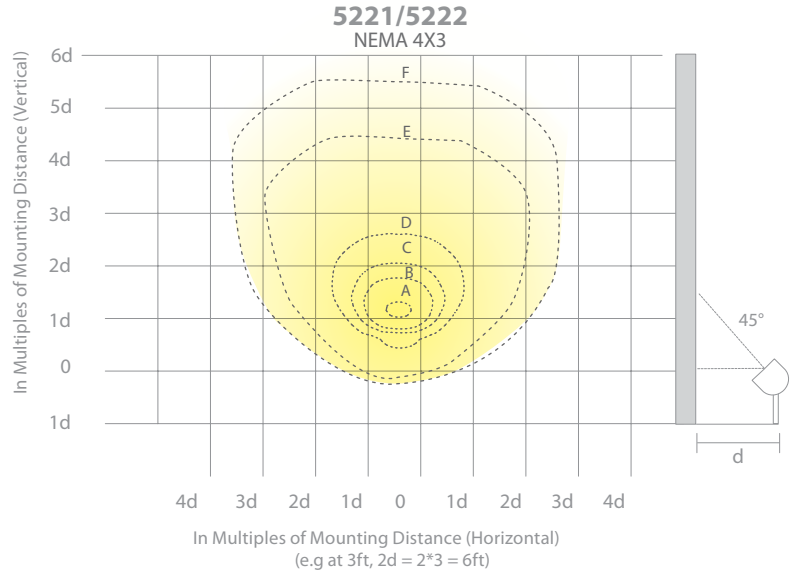

FIXTURE	MOUNTING DISTANCE (d)	A	B	C	D	E	F
5221/5222 (5X4)	3ft	28.9fc	13.4fc	7.9fc	3fc	0.36fc	0.14fc
	4ft	16.3fc	7.5fc	4.4fc	1.7fc	0.20fc	0.08fc
	5ft	10.4fc	4.8fc	2.8fc	1.1fc	0.13fc	0.05fc
	6ft	7.3fc	3.4fc	2.0fc	0.75fc	0.09fc	0.04fc
	7ft	5.3fc	2.5fc	1.5fc	0.55fc	0.07fc	0.03fc
	8ft	4.1fc	1.9fc	1.1fc	0.42fc	0.05fc	0.02fc
	9ft	3.2fc	1.5fc	0.87fc	0.33fc	0.04fc	0.02fc
10ft	2.6fc	1.2fc	0.71fc	0.27fc	0.03fc	0.01fc	

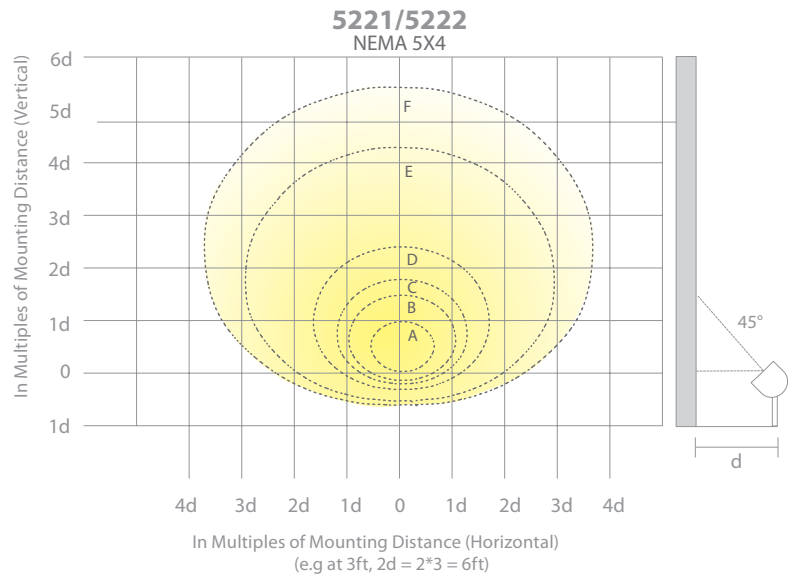

FIXTURE	MOUNTING DISTANCE (d)	A	B	C	D	E	F
5221/5222 (6X5)	3ft	28.9fc	13.6fc	8.8fc	4.1fc	0.70fc	0.32fc
	4ft	16.3fc	7.7fc	5.0fc	2.3fc	0.39fc	0.18fc
	5ft	10.4fc	4.9fc	3.2fc	1.5fc	0.25fc	0.12fc
	6ft	7.2fc	3.4fc	2.2fc	1.0fc	0.18fc	0.08fc
	7ft	5.3fc	2.5fc	1.6fc	0.75fc	0.13fc	0.06fc
	8ft	4.1fc	1.9fc	1.2fc	0.58fc	0.10fc	0.05fc
	9ft	3.2fc	1.5fc	0.98fc	0.45fc	0.08fc	0.04fc
10ft	2.6fc	1.2fc	0.79fc	0.37fc	0.06fc	0.03fc	

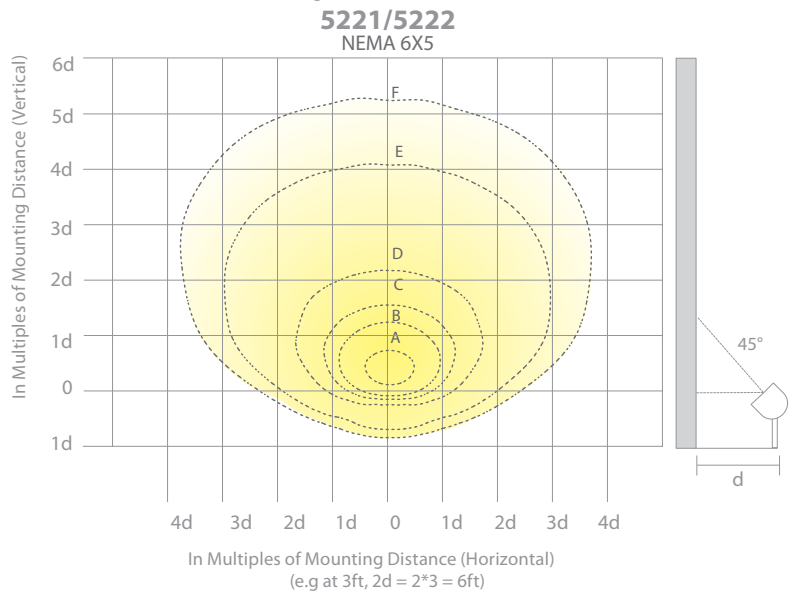

Index

#

12V OUTDOOR	97 / 98
12V & 120V RECTANGULAR STEP & WALL LIGHTS	93 / 94
24V OUTDOOR PRO+	81 / 82
24VDC OUTDOOR	79 / 80
24VDC OUTDOOR RGBWW	83 / 84
1" RECESSED INGROUNDS + INDICATORS	29
2" RECESSED INGROUNDS + INDICATORS.....	30
3" IN-GROUND.....	21 / 22

A

ACCENT	7 / 8
ACCESSORIES.....	115 / 116 / 117
ADJUSTABLE BEAM WALL WASH	17 / 18
AREA	51
ARCHETYPE (BOLLARD)	71 / 72
ARCHETYPE (PENDANT)	74
ARCHETYPE (POST MOUNT)	74
ARCHETYPE (WALL SCONCE)	73

B

BALANCE (DOUBLE)	56
BALANCE (SINGLE).....	55

C

CANOPY	50
CHAMBER (BOLLARD)	65 / 66
CHAMBER (PENDANT)	68
CHAMBER (POST MOUNT)	68
CHAMBER (WALL SCONCE)	67
CYLINDER	37 / 38

D

DECK & PATIO	85 / 86
--------------------	---------

E

ECLIPSE	58
ENDURANCE (BRICK LIGHTS)	101 / 102
ENDURANCE (FLOOD LIGHTS)	99 / 100
ENDURANCE SPOT DOUBLE (FLOOD LIGHTS)	104
ENDURANCE SPOT SINGLE (FLOOD LIGHTS)	103
ENDURANCE WALL MOUNTED SPOT (SINGLE & DOUBLE)	105 / 106
ENDURANCE WALL PACK (FIN & HAWK).....	107 / 108

G

GRAND ACCENT	5 / 6
GRAND IN-GROUND	23 / 24
GATE	61 / 62

H

HARDSCAPE	41 / 42
HORNET	13 / 14

I

INTERBEAM	11 / 12
INTERPATH	47 / 48

L

LEDGE	52
LINEAR PATH LIGHT	45 / 46

M

MINI ACCENT	9
MINI ACCENT (PATH)	10
MINI WALL WASH	20

Q

QUAD	57
------------	----

R

RUBIX (DECORATIVE CEILING)	111
RUBIX (DECORATIVE WALL MOUNT)	112

S

SCOOP (BOLLARD)	63 / 64
SCOOP (DECORATIVE WALL MOUNT)	112
SLIDE	53 / 54
SLOPE	59
STEP LIGHTS	89 / 90
SURFACE MOUNT INDICATOR	27 / 28
SURFACE MOUNT STEP LIGHTS	91 / 92
SUBMERSIBLE 2" INGROUND	31 / 32

T

TIKI	49
TOWER	69 / 70
TREE LIGHTS	35 / 36
TUBE (DECORATIVE CEILING MOUNT)	113
TUBE (DECORATIVE PENDANT)	113
TUBE (DECORATIVE WALL MOUNT)	114

U

UNDERWATER SPOT	33 / 34
-----------------------	---------





YOUR VISION.
WAC DELIVERS

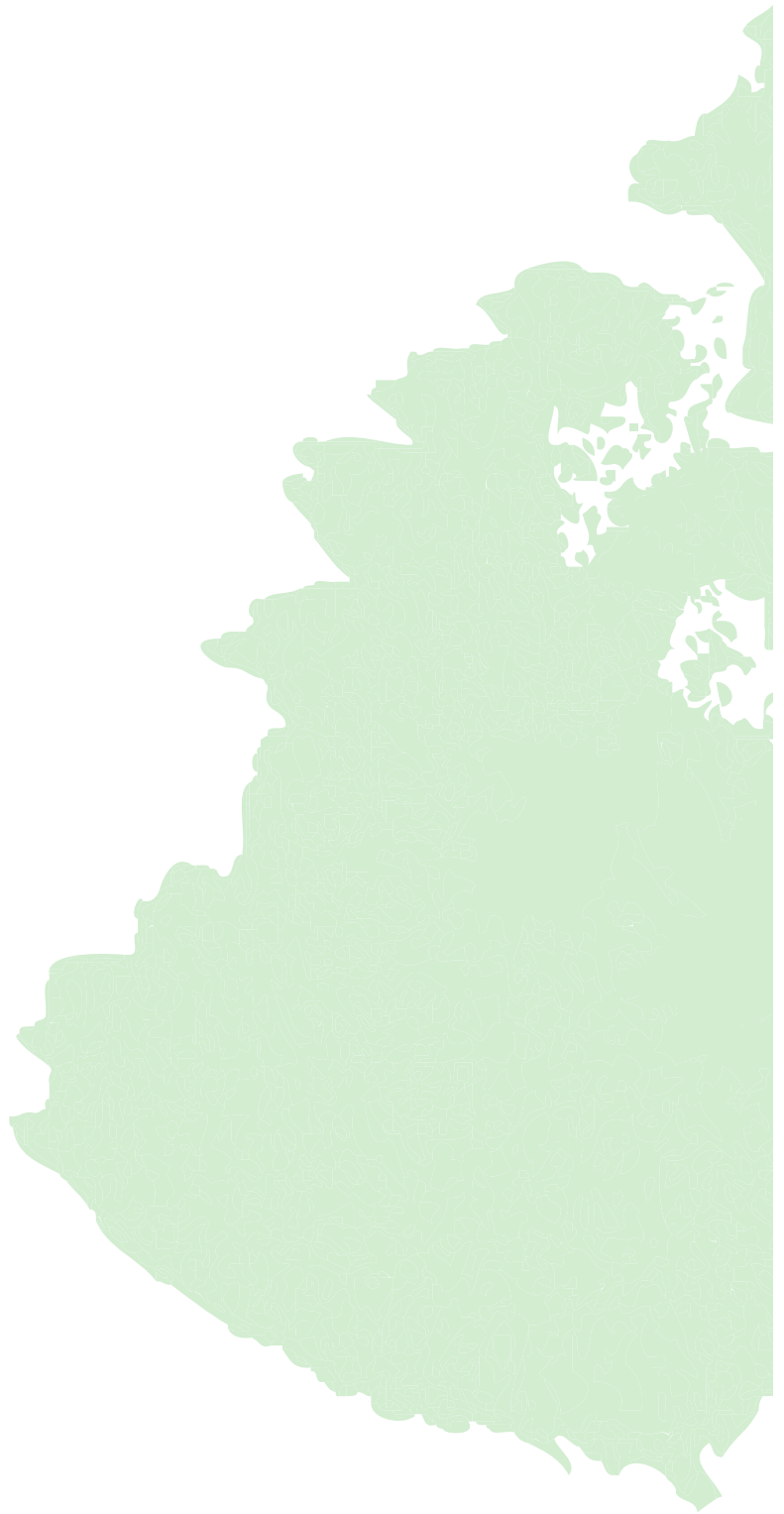

Headquarters

Tel: 800.526.2588

Fax: 800.526.5285

44 Harbor Park Dr
Port Washington, NY 11050

Distribution and Assembly Facilities

South East

1600 Distribution Ct
Lithia Springs, GA 30122

Central

1700 South J Elmer Freeway
Suite 100
Cedar Hill, TX 75104

West

1750 S Archibald Ave
Ontario, CA 91761

Consult our facility to take advantage of our custom capabilities in large quantities.

For up to date product specifications and assistance

please visit wacighting.com

or call

1-800-526-2588



WACLIGHTING.COM/LANDSCAPE



WAC[®]
LANDSCAPE LIGHTING

2024 CATALOG

WAC Landscape Lighting technology is protected by several patents and pending patent applications, including U.S. Patent Nos. 9,784,440, 10,190,757, 10,208,935, 10,323,832, 10,330,294, 10,465,888, 10,571,101, 10,598,358, 10,920,971, 10,928,045, 10,941,924, 10,962,209, 10,969,088, 10,989,401, 11,199,319, 11,274,816, 11,280,483, 11,460,177, 11,408,597, 11,686,459.

WAC Landscape Lighting technology and designs are protected by several patents and patent applications. WAC Landscape Lighting will not hesitate to enforce its intellectual property rights through injunctive relief and seek further relief through damages if it has reason to believe its patents are being infringed.

Copyright © 2024 WAC Landscape Lighting. All rights reserved. This catalog is copyrighted and WAC Landscape Lighting will use all measures available to it under the law against anyone who copies or derives from its copyrighted work.

WAC Landscape Lighting retains the right to modify the design of its products at any time as part of the company's continuous improvement program. Please refer to our website for the latest product specifications.

800.526.2588 | wacighting.com/landscape